

PHG 1136-8M-30 SKF

HiTD belt

TYPE: Classical timing belts, Oneway, HiTD, Section 8M (SKF)

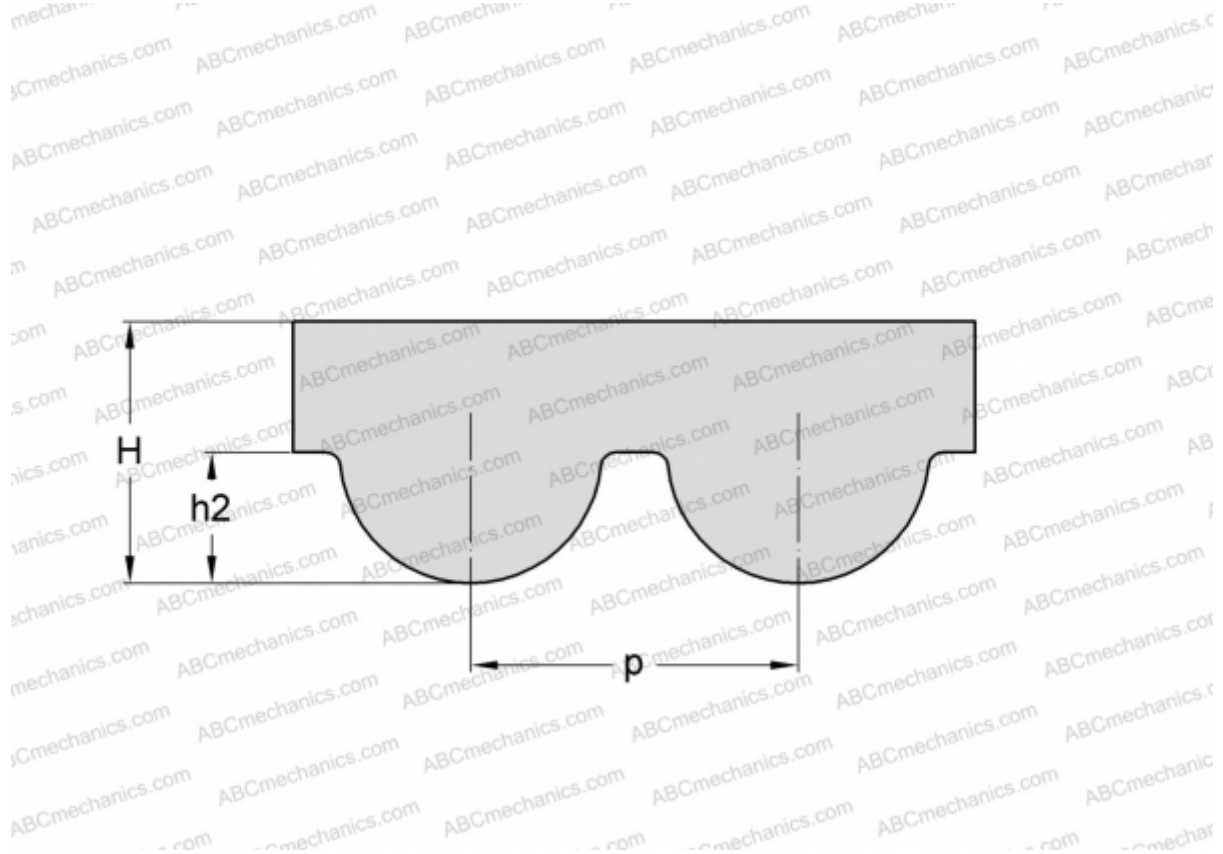

Technical specification

DIMENSIONS, MM

Pitch teeth, p	8,000
Estimated length	1136,000
Width, W	30,000
Height, H	5,600
h_2	3,880
Number of teeth	142

MANUFACTURER

[SKF](#)