

PHG 2160-8M-50 SKF

HiTD belt

TYPE: Classical timing belts, Oneway, HiTD, Section 8M (SKF)

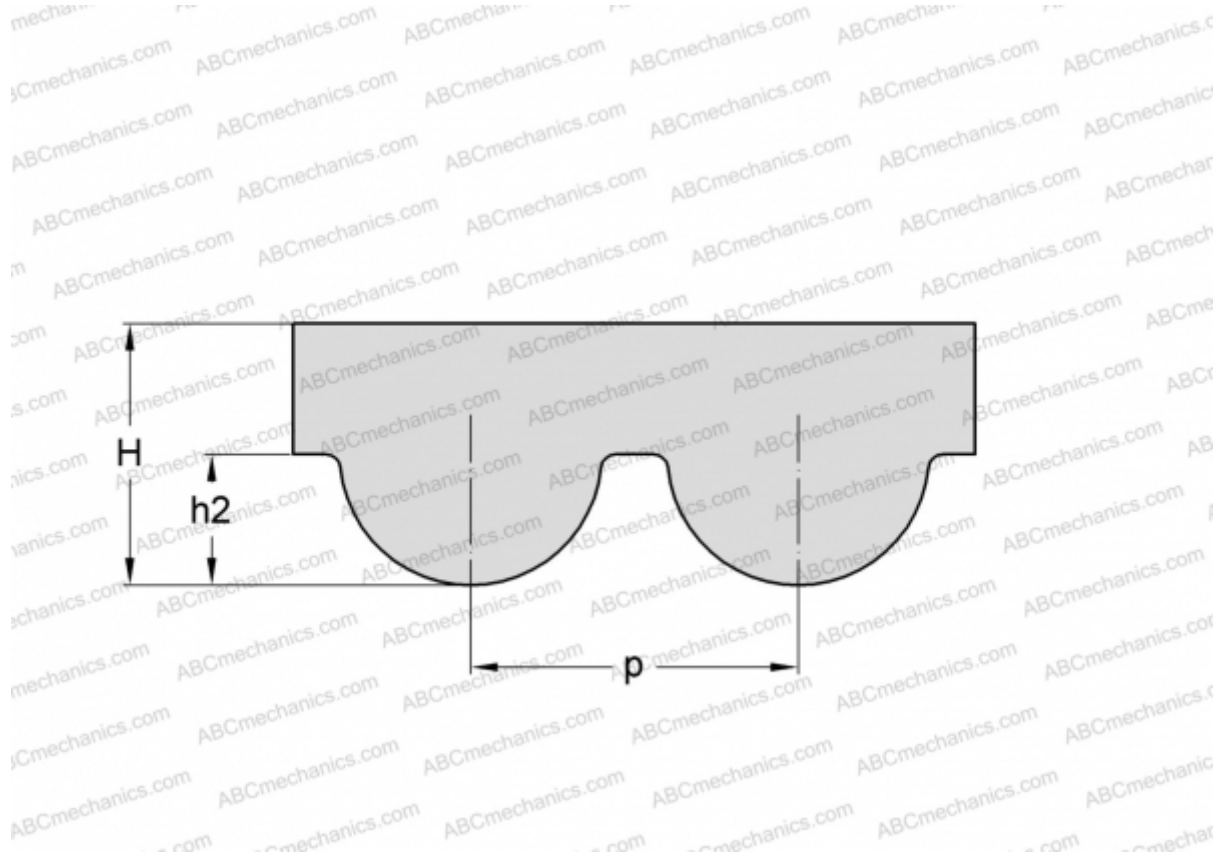

Technical specification

DIMENSIONS, MM

| | |
|------------------|----------|
| Pitch teeth, p | 8,000 |
| Estimated length | 2160,000 |
| Width, W | 50,000 |
| Height, H | 5,600 |
| h_2 | 3,880 |
| Number of teeth | 270 |

MANUFACTURER

[SKF](#)