

PHG 2208-8M-20 SKF

HiTD belt

TYPE: Classical timing belts, Oneway, HiTD, Section 8M (SKF)

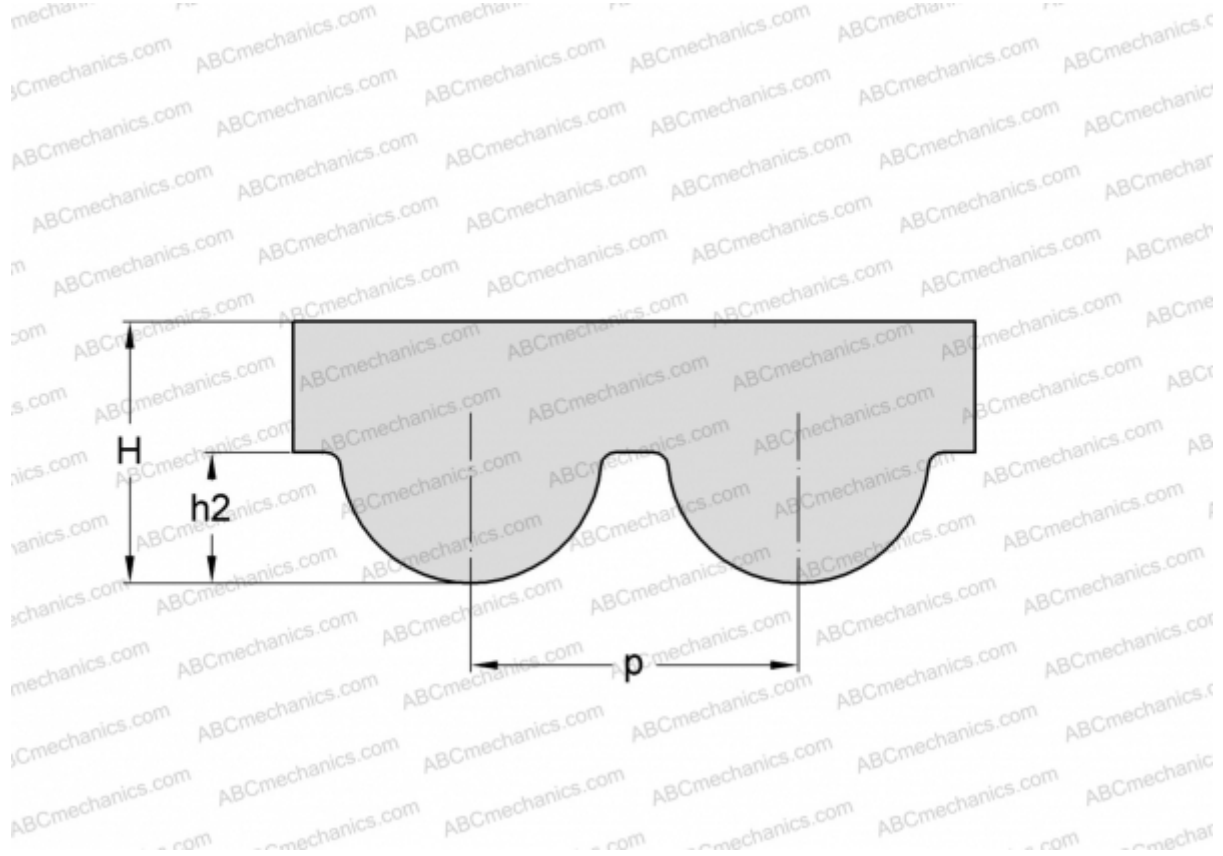

Technical specification

DIMENSIONS, MM

| | |
|------------------|----------|
| Pitch teeth, p | 8,000 |
| Estimated length | 2208,000 |
| Width, W | 20,000 |
| Height, H | 5,600 |
| h_2 | 3,880 |
| Number of teeth | 276 |

MANUFACTURER

[SKF](#)