

PHG 2240-8M-20 SKF

HiTD belt

TYPE: Classical timing belts, Oneway, HiTD, Section 8M (SKF)

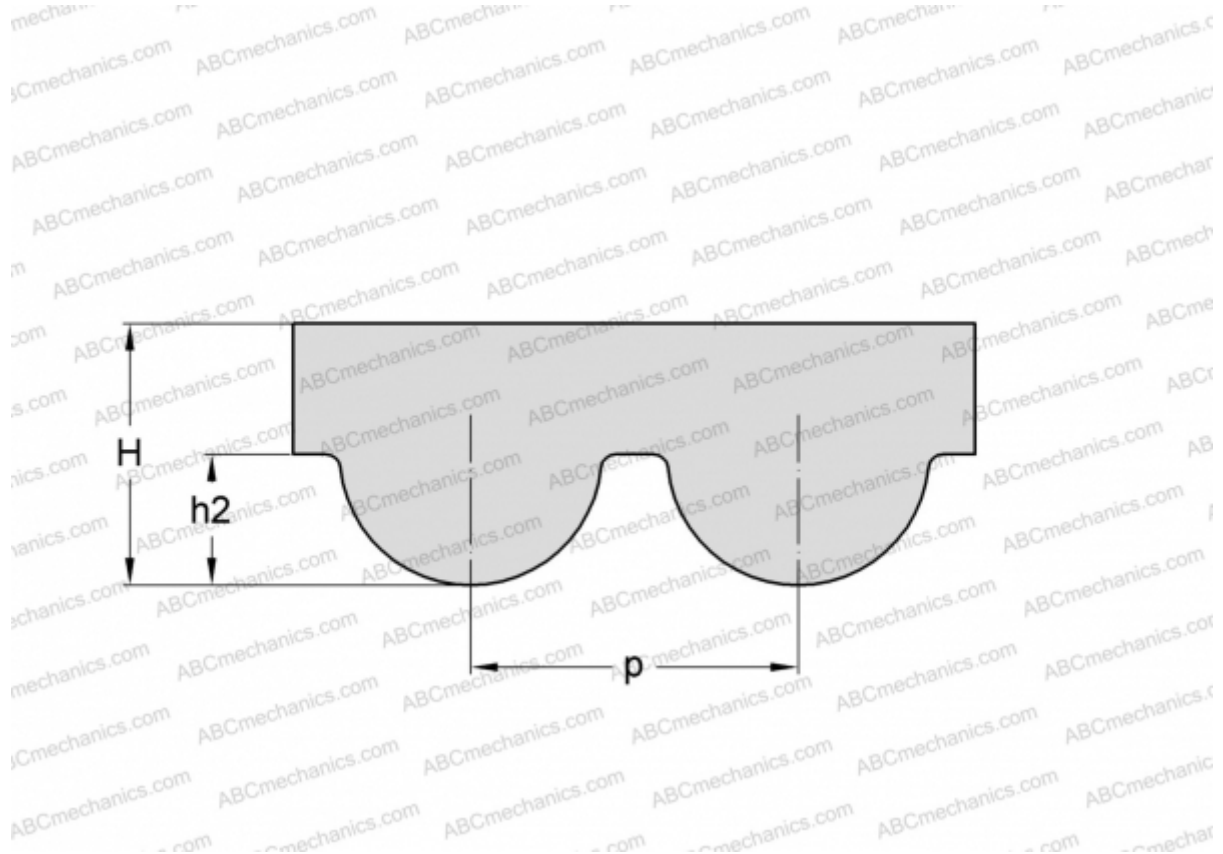

Technical specification

DIMENSIONS, MM

Pitch teeth, p	8,000
Estimated length	2240,000
Width, W	20,000
Height, H	5,600
h_2	3,880
Number of teeth	280

MANUFACTURER

[SKF](#)