

PHG 1120-14M-55 SKF

HiTD belt

TYPE: Classical timing belts, Oneway, HiTD, Section 14M (SKF)

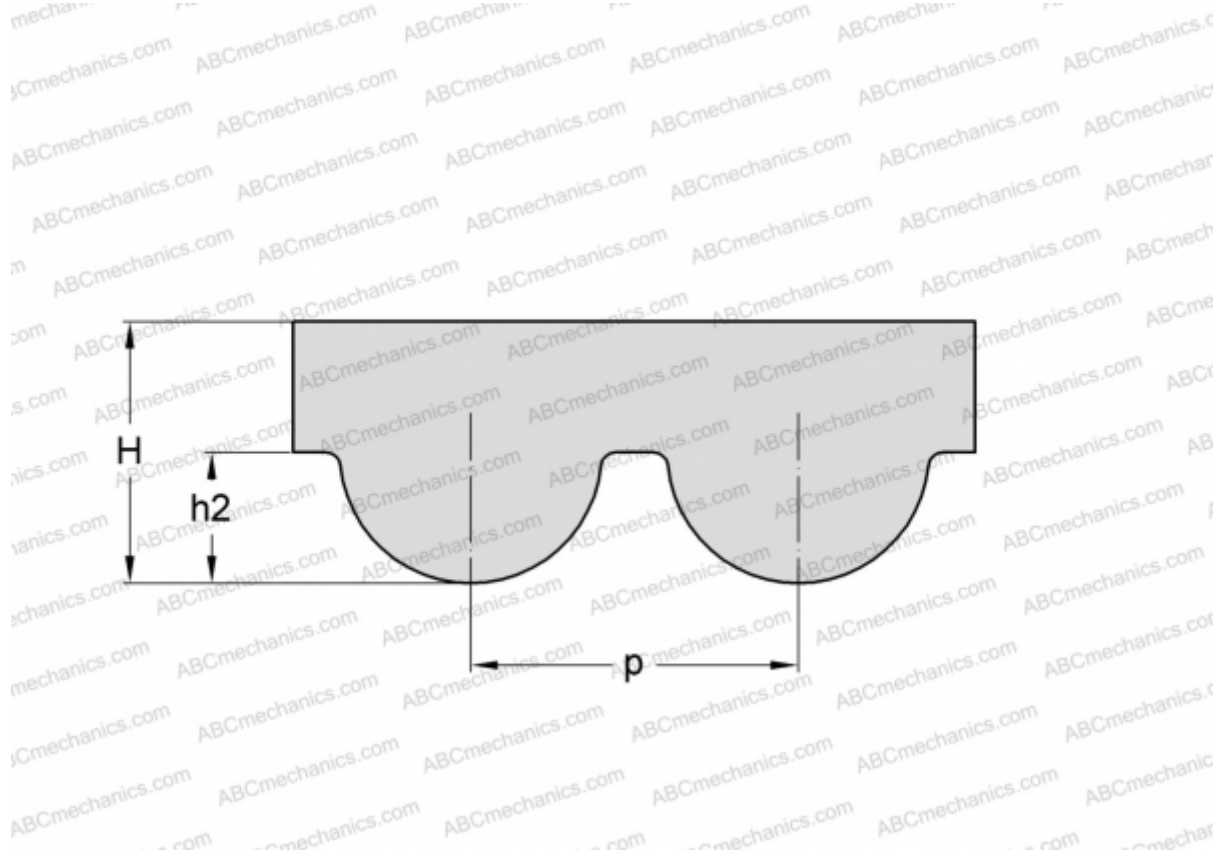

Technical specification

DIMENSIONS, MM

| | |
|------------------|----------|
| Pitch teeth, p | 14,000 |
| Estimated length | 1120,000 |
| Width, W | 55,000 |
| Height, H | 10,000 |
| h_2 | 6,100 |
| Number of teeth | 80 |

MANUFACTURER

[SKF](#)