

## PHG 1316-14M-40 SKF

HiTD belt

TYPE: Classical timing belts, Oneway, HiTD, Section 14M (SKF)

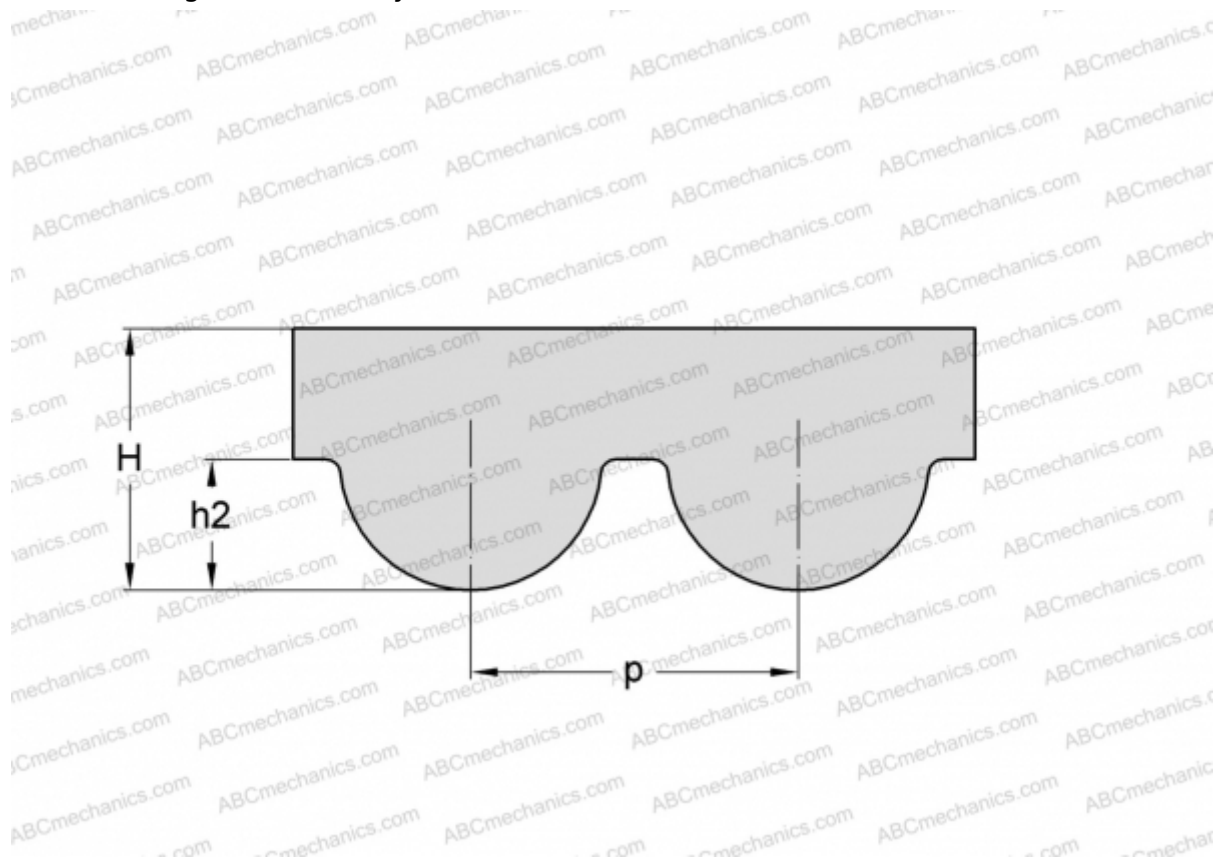

### Technical specification

#### DIMENSIONS, MM

Pitch teeth, $p$	14,000
Estimated length	1316,000
Width, $W$	40,000
Height, $H$	10,000
$h2$	6,100
Number of teeth	94

#### MANUFACTURER

[SKF](#)