

PHG 1470-14M-40 SKF

HiTD belt

TYPE: Classical timing belts, Oneway, HiTD, Section 14M (SKF)

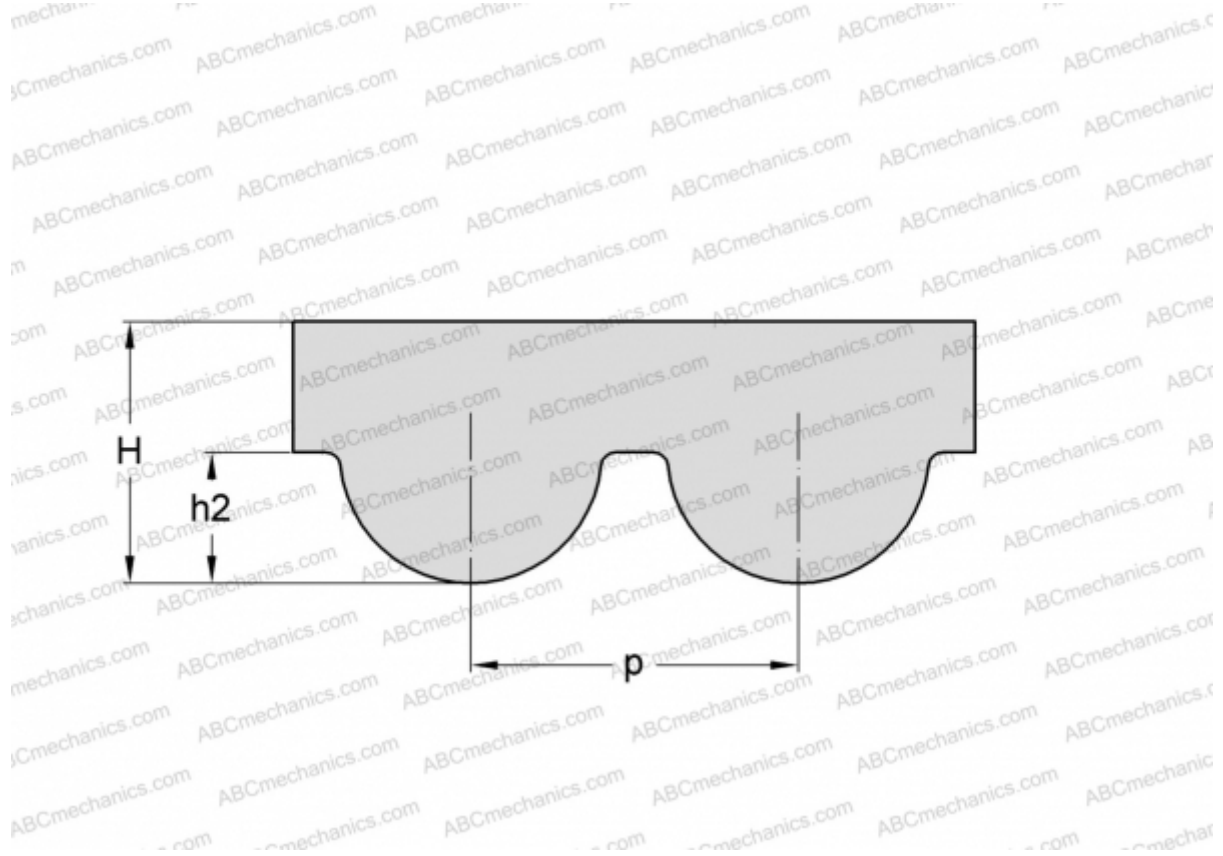

Technical specification

DIMENSIONS, MM

Pitch teeth, p	14,000
Estimated length	1470,000
Width, W	40,000
Height, H	10,000
h_2	6,100
Number of teeth	105

MANUFACTURER

[SKF](#)