

PHG 3108-14M-115 SKF

HiTD belt

TYPE: Classical timing belts, Oneway, HiTD, Section 14M (SKF)

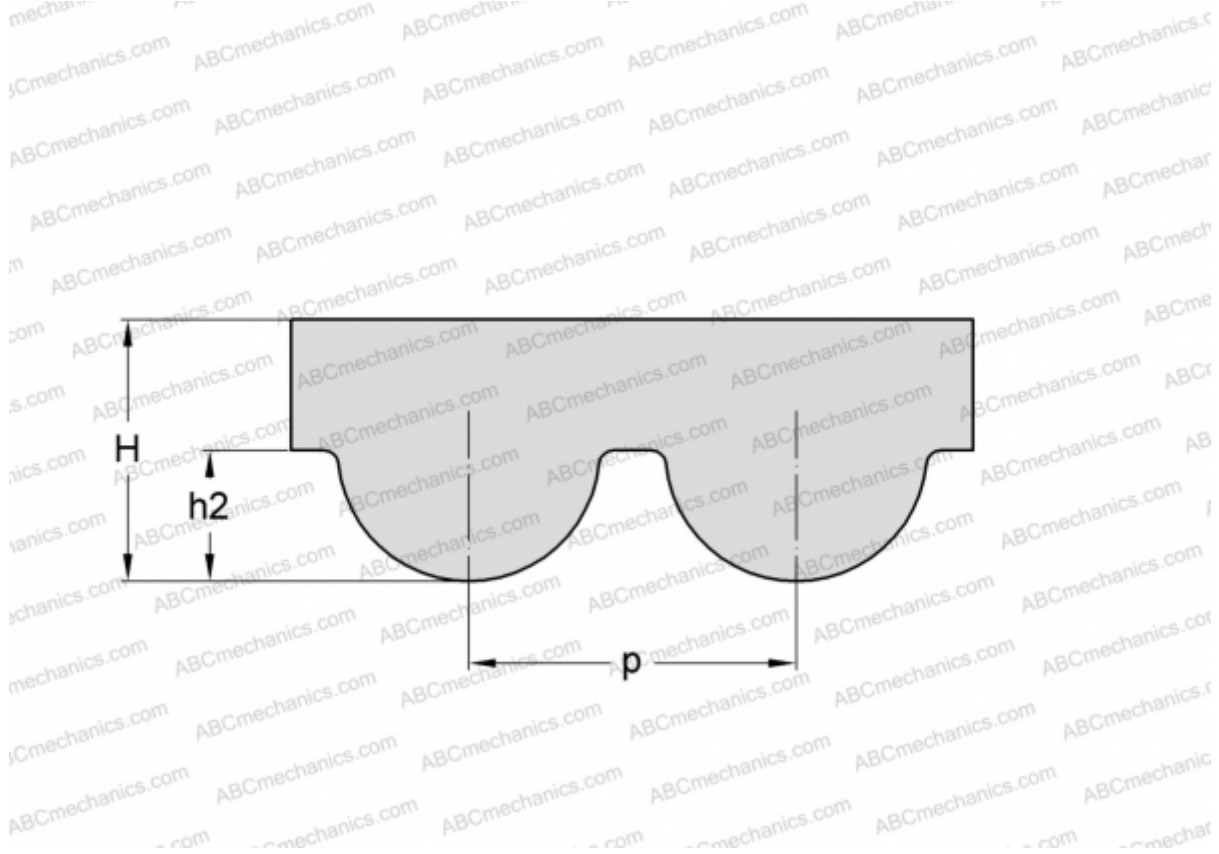

Technical specification

DIMENSIONS, MM

Pitch teeth, p	14,000
Estimated length	3108,000
Width, W	115,000
Height, H	10,000
h_2	6,100
Number of teeth	222

MANUFACTURER

[SKF](#)