

## PHG 5040-14M-115 SKF

HiTD belt

TYPE: Classical timing belts, Oneway, HiTD, Section 14M (SKF)

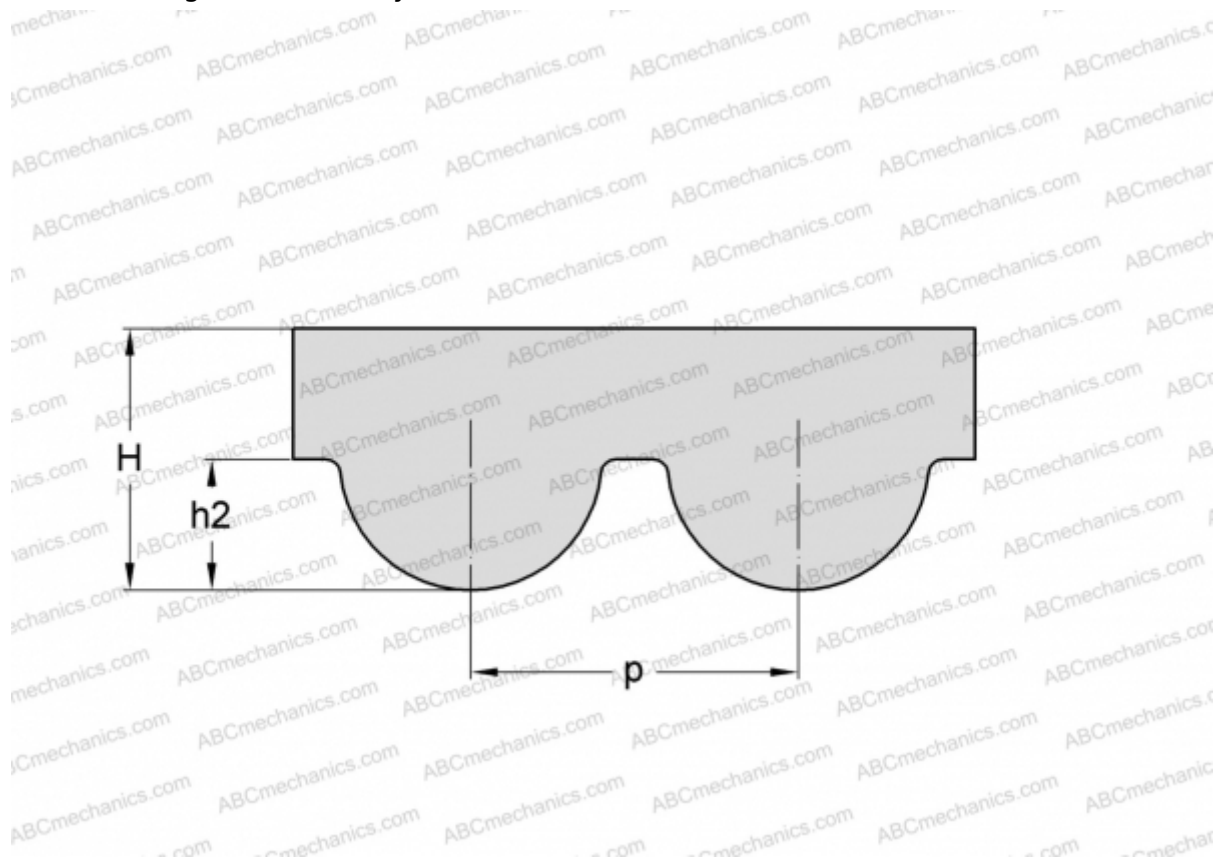

### Technical specification

#### DIMENSIONS, MM

Pitch teeth, $p$	14,000
Estimated length	5040,000
Width, $W$	115,000
Height, $H$	10,000
$h_2$	6,100
Number of teeth	360

#### MANUFACTURER

[SKF](#)