

## PHG S2M-126-15 SKF

HiTD belt

TYPE: Classical timing belts, Oneway, Super Torque, Section S2M (SKF)

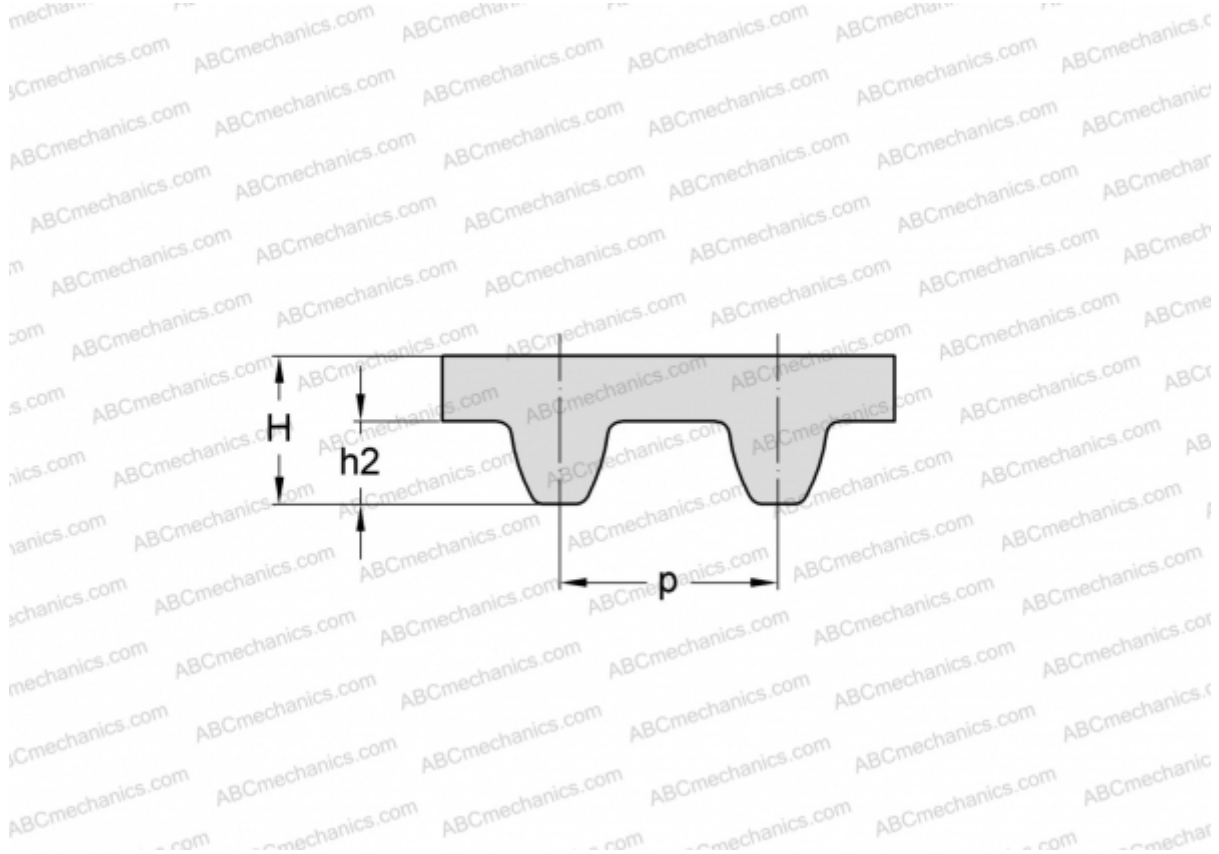

### Technical specification

#### DIMENSIONS, MM

Pitch teeth, p	2,000
Estimated length	126,000
Width, W	15,000
Height, H	1,360
h2	0,760
Number of teeth	63

#### MANUFACTURER

[SKF](#)