

## PHG S2M-204-15 SKF

HiTD belt

TYPE: Classical timing belts, Oneway, Super Torque, Section S2M (SKF)

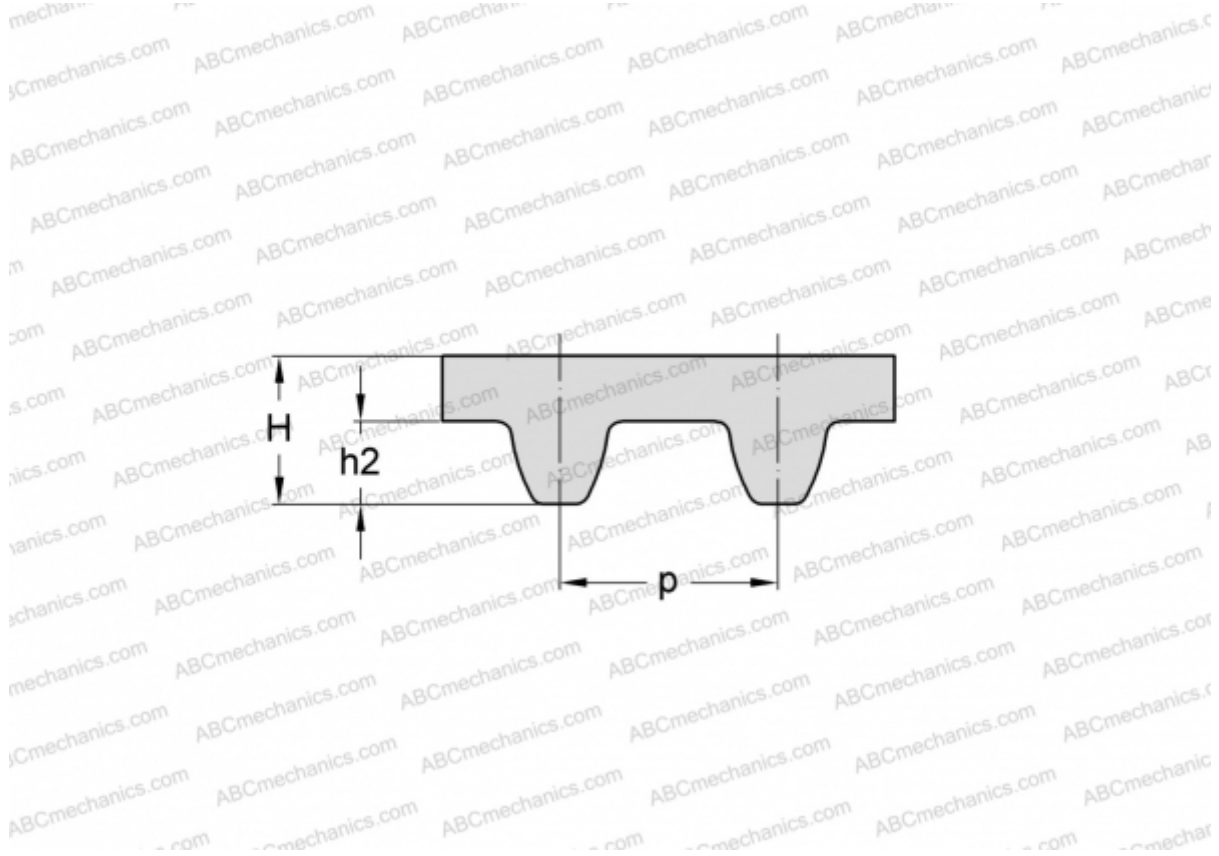

### Technical specification

#### DIMENSIONS, MM

Pitch teeth, $p$	2,000
Estimated length	204,000
Width, $W$	15,000
Height, $H$	1,360
$h2$	0,760
Number of teeth	102

#### MANUFACTURER

[SKF](#)