

PHG S2M-236-15 SKF

HiTD belt

TYPE: Classical timing belts, Oneway, Super Torque, Section S2M (SKF)

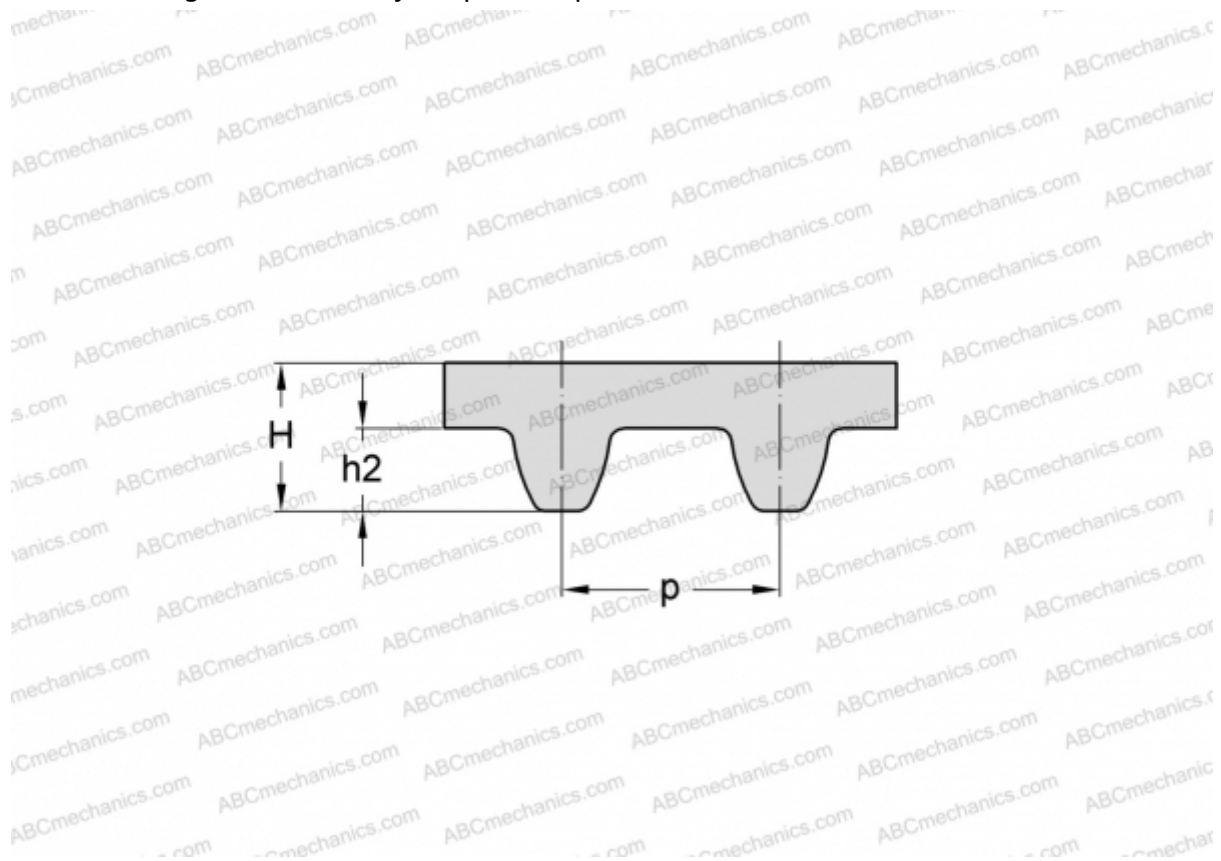

Technical specification

DIMENSIONS, MM

Pitch teeth, p	2,000
Estimated length	236,000
Width, W	15,000
Height, H	1,360
$h2$	0,760
Number of teeth	118

MANUFACTURER

[SKF](#)