

PHG S2M-494-9 SKF

HiTD belt

TYPE: Classical timing belts, Oneway, Super Torque, Section S2M (SKF)

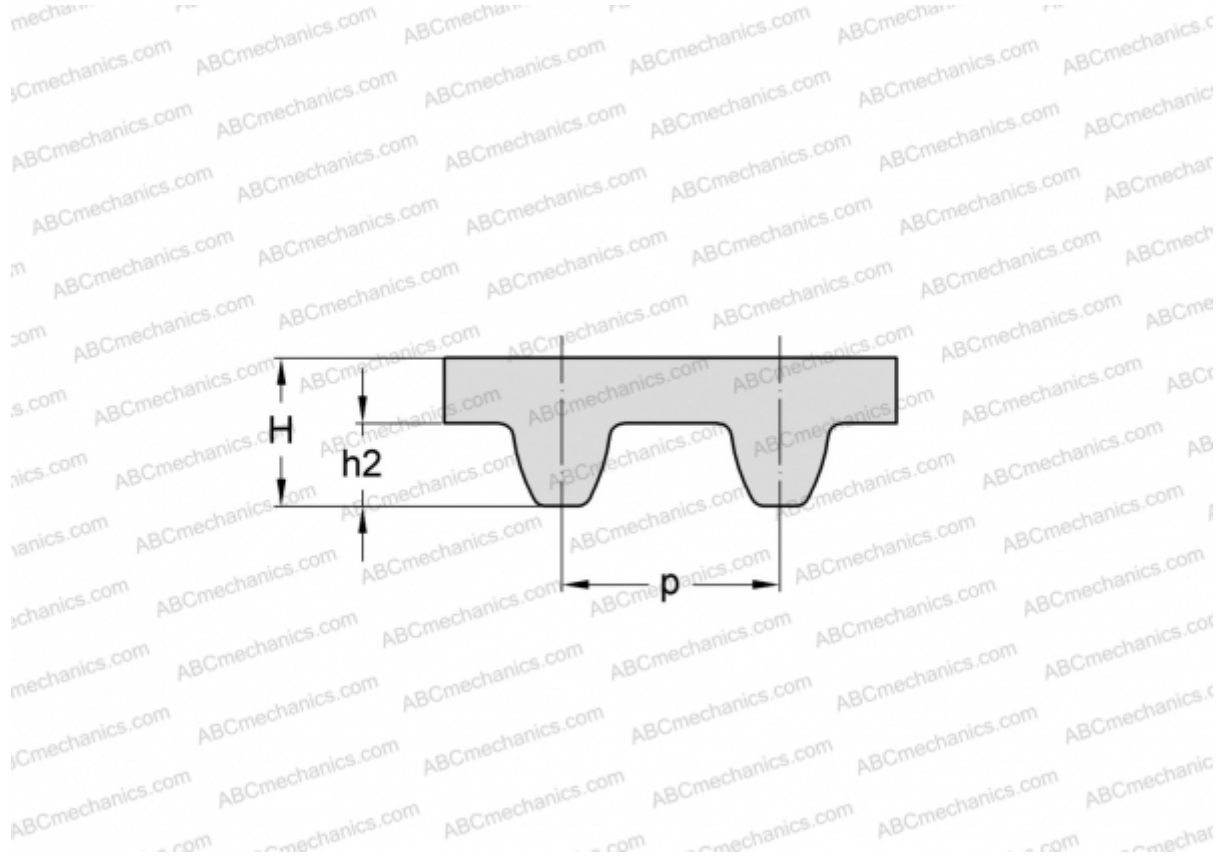

Technical specification

DIMENSIONS, MM

Pitch teeth, p	2,000
Estimated length	494,000
Width, W	9,000
Height, H	1,360
$h2$	0,760
Number of teeth	247

MANUFACTURER

[SKF](#)