

## PHG S3M-210-15 SKF

HiTD belt

TYPE: Classical timing belts, Oneway, Super Torque, Section S3M (SKF)

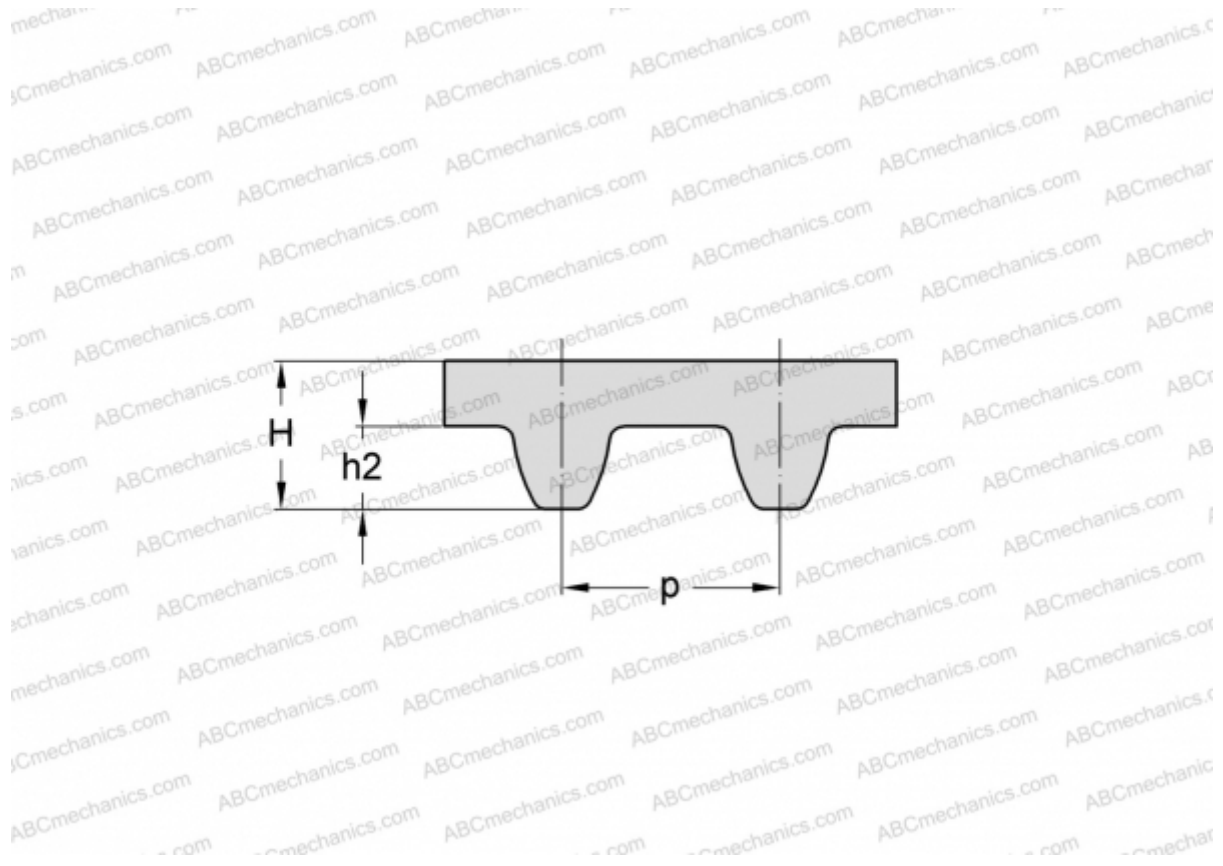

### Technical specification

#### DIMENSIONS, MM

Pitch teeth, p	3,000
Estimated length	210,000
Width, W	15,000
Height, H	2,200
h2	1,140
Number of teeth	70

#### MANUFACTURER

[SKF](#)