

## PHG S3M-264-15 SKF

HiTD belt

TYPE: Classical timing belts, Oneway, Super Torque, Section S3M (SKF)

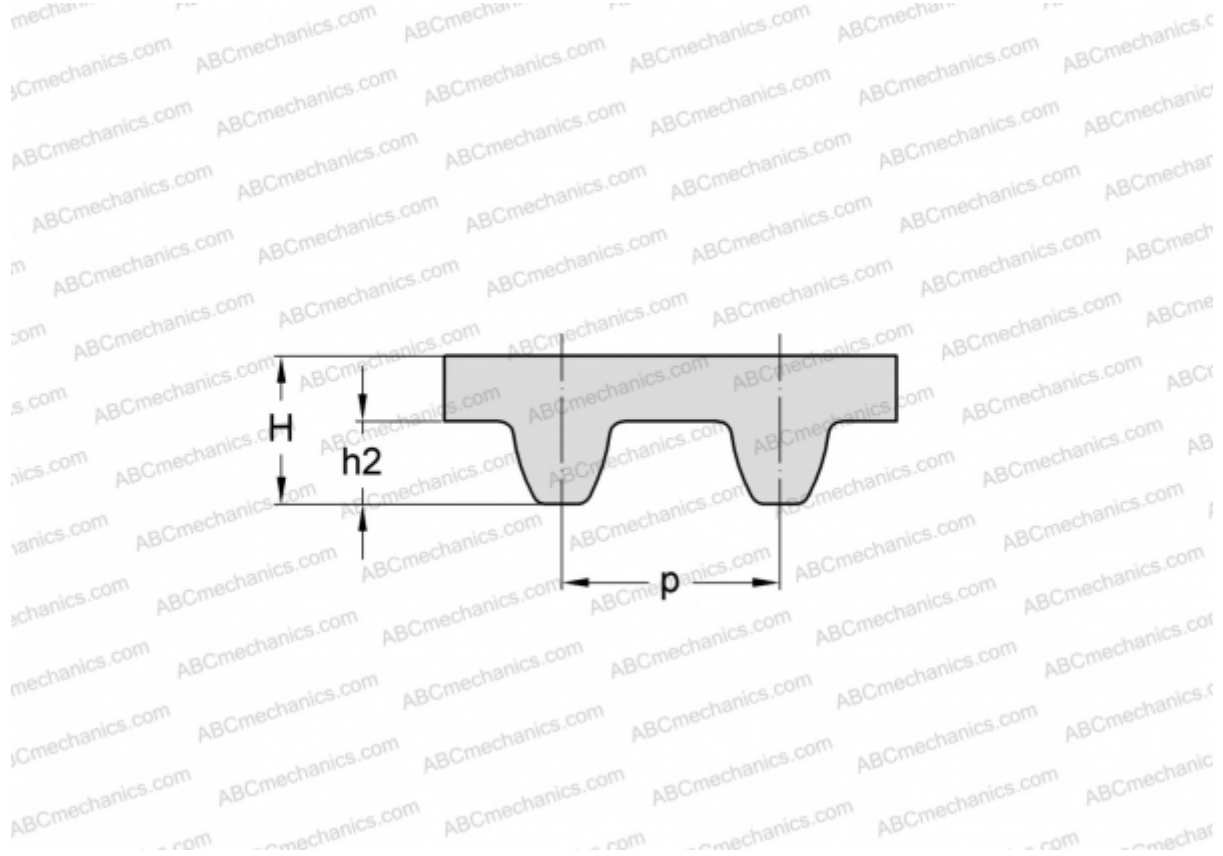

### Technical specification

#### DIMENSIONS, MM

Pitch teeth, $p$	3,000
Estimated length	264,000
Width, $W$	15,000
Height, $H$	2,200
$h2$	1,140
Number of teeth	88

#### MANUFACTURER

[SKF](#)