

## PHG S3M-333-9 SKF

HiTD belt

TYPE: Classical timing belts, Oneway, Super Torque, Section S3M (SKF)

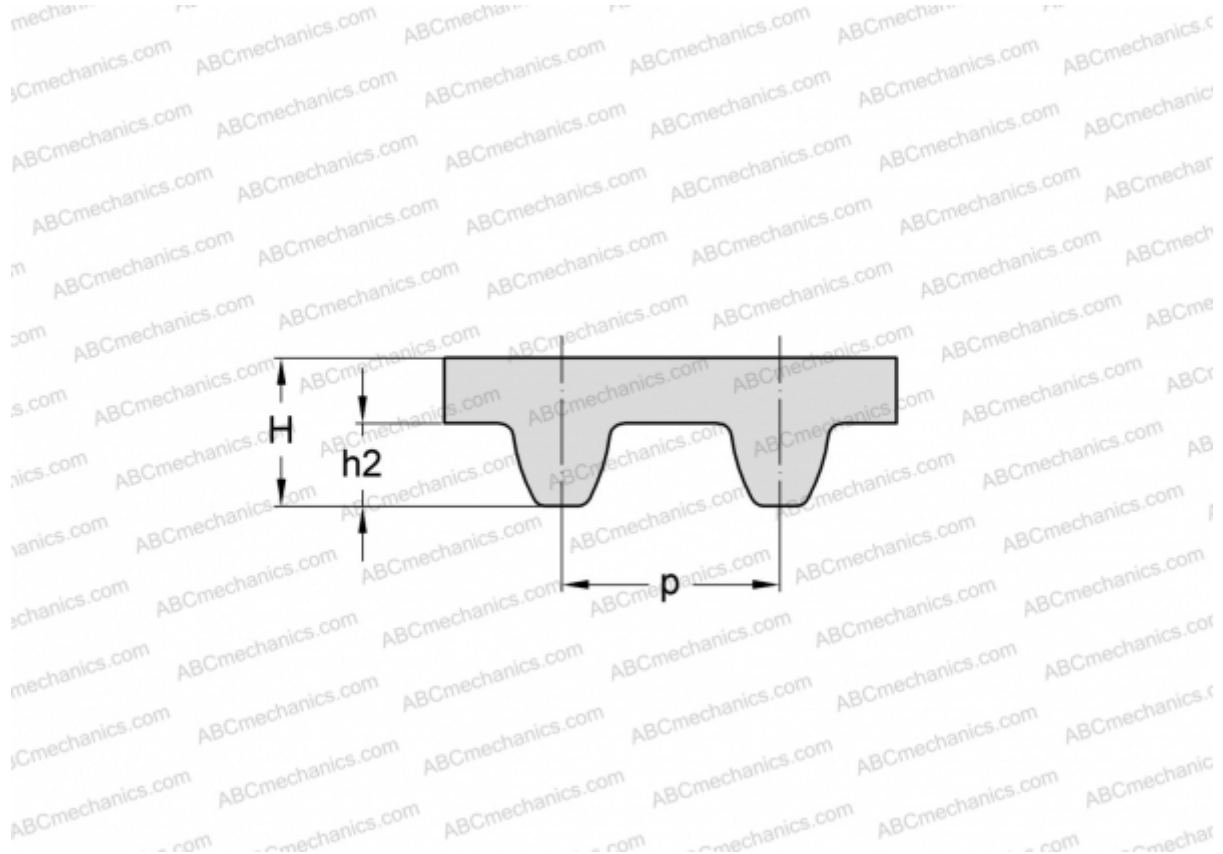

### Technical specification

#### DIMENSIONS, MM

Pitch teeth, p	3,000
Estimated length	333,000
Width, W	9,000
Height, H	2,200
h2	1,140
Number of teeth	111

#### MANUFACTURER

[SKF](#)