

PHG S3M-405-15 SKF

HiTD belt

TYPE: Classical timing belts, Oneway, Super Torque, Section S3M (SKF)

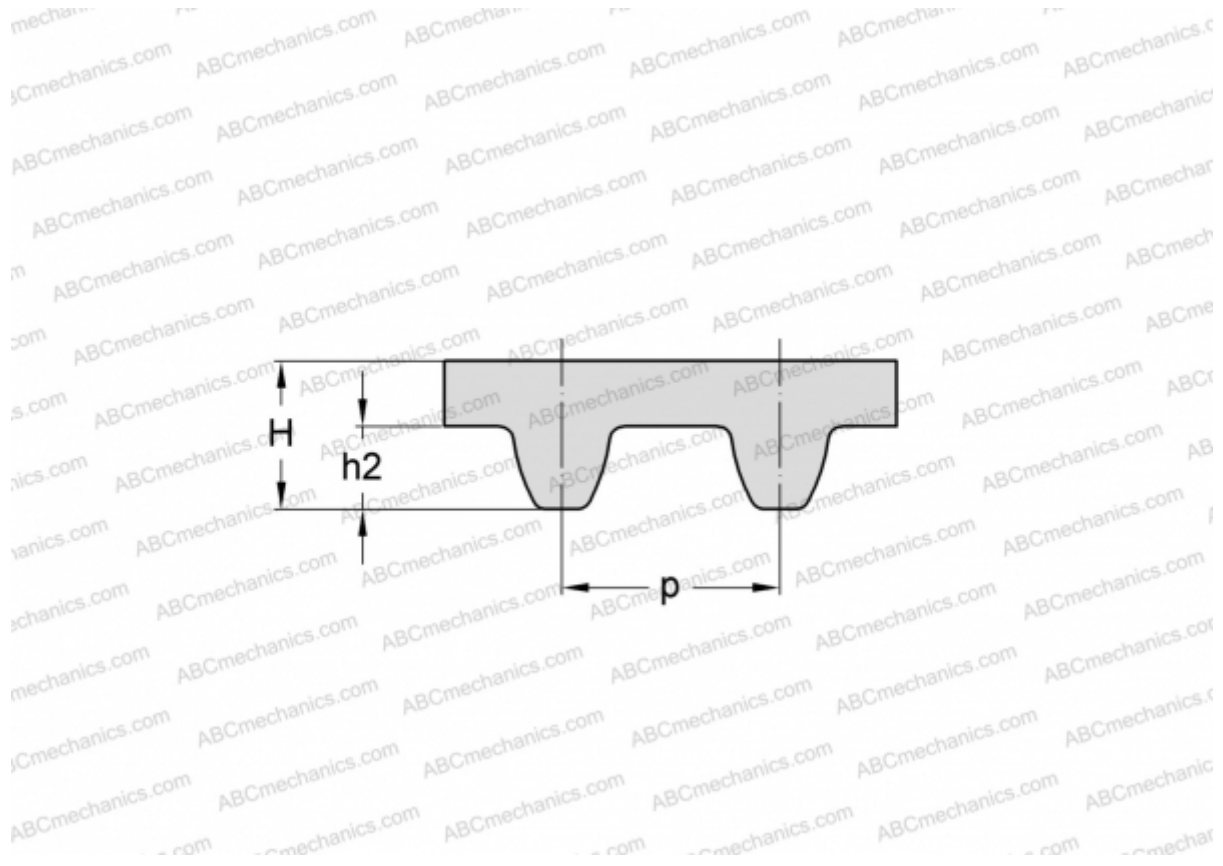

Technical specification

DIMENSIONS, MM

Pitch teeth, p	3,000
Estimated length	405,000
Width, W	15,000
Height, H	2,200
h2	1,140
Number of teeth	135

MANUFACTURER

[SKF](#)