

## PHG S3M-507-15 SKF

HiTD belt

TYPE: Classical timing belts, Oneway, Super Torque, Section S3M (SKF)

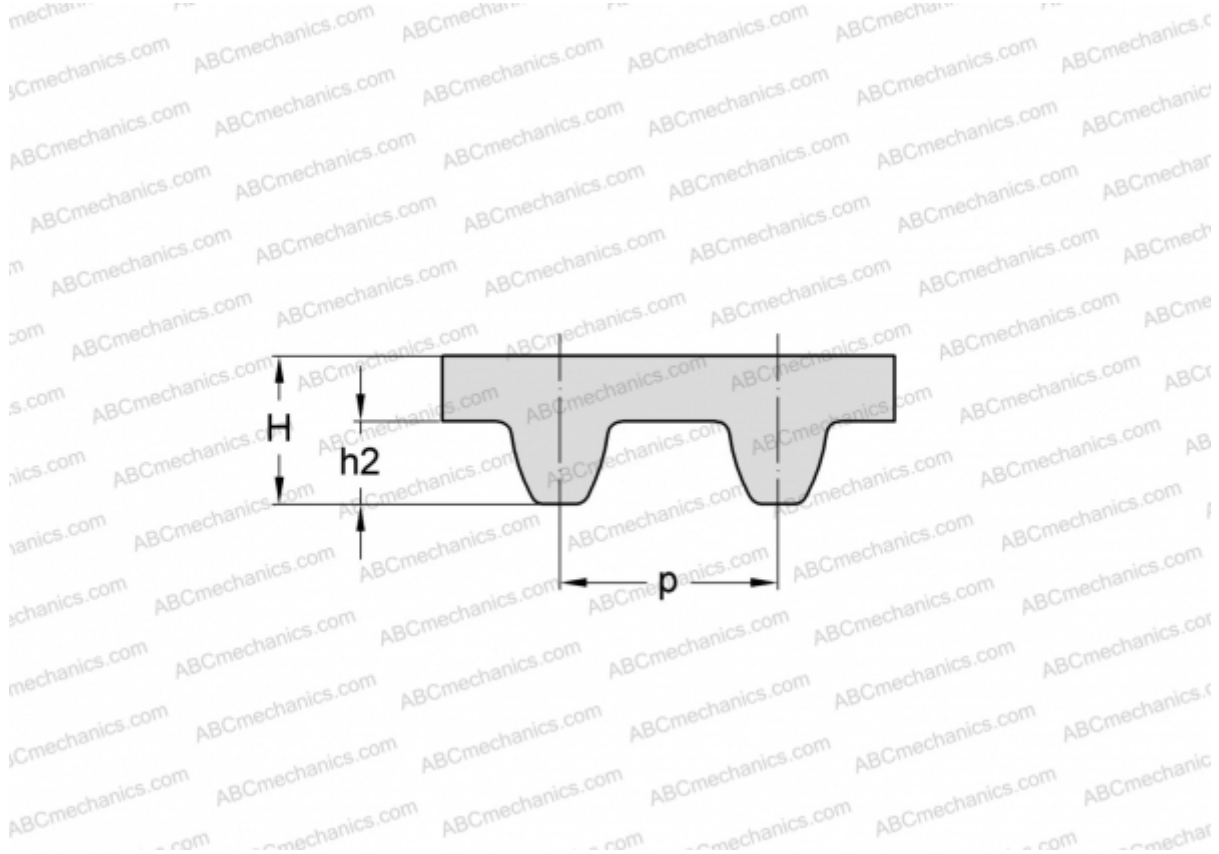

### Technical specification

#### DIMENSIONS, MM

Pitch teeth, p	3,000
Estimated length	507,000
Width, W	15,000
Height, H	2,200
h2	1,140
Number of teeth	169

#### MANUFACTURER

[SKF](#)