

PHG S3M-4704-15 SKF

HiTD belt

TYPE: Classical timing belts, Oneway, Super Torque, Section S3M (SKF)

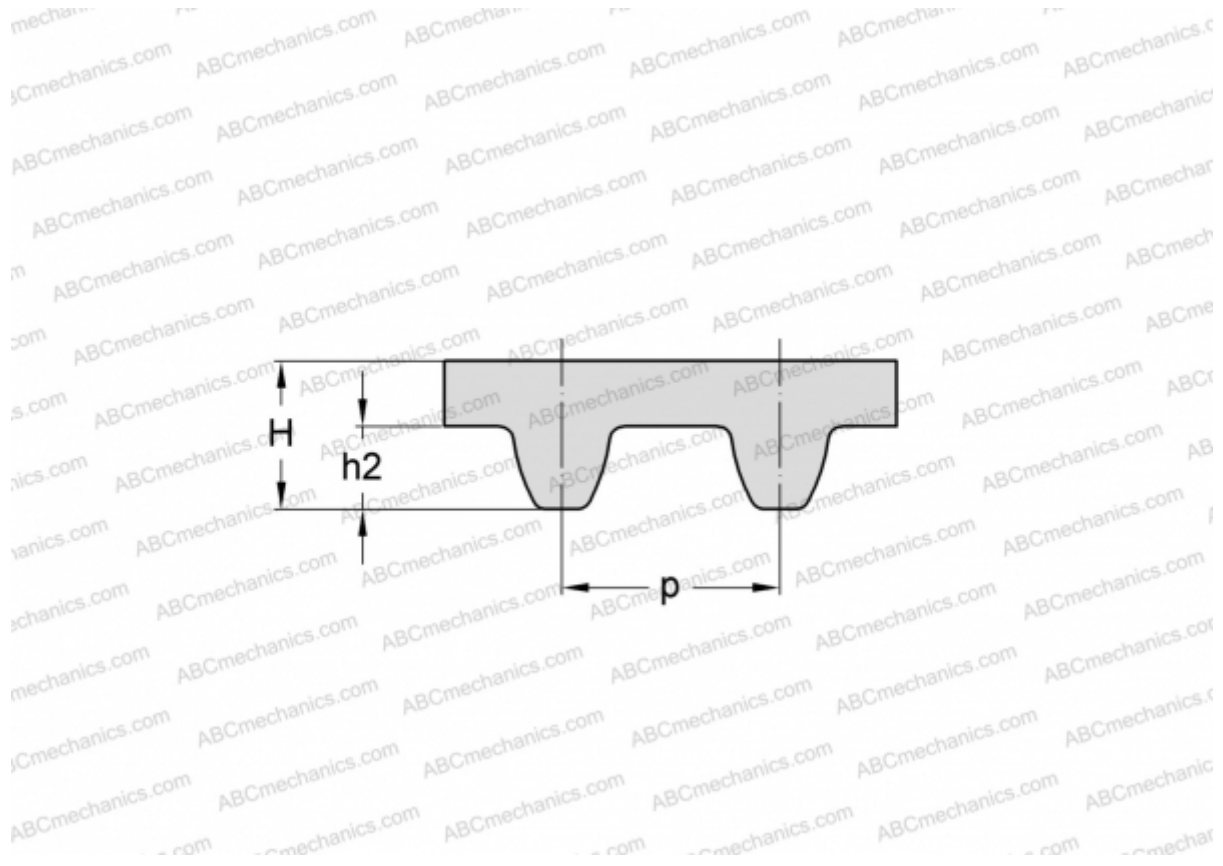

Technical specification

DIMENSIONS, MM

Pitch teeth, p	3,000
Estimated length	4704,000
Width, W	15,000
Height, H	2,200
$h2$	1,140
Number of teeth	1568

MANUFACTURER

[SKF](#)