

PHG S4.5M-180-9 SKF

HiTD belt

TYPE: Classical timing belts, Oneway, Super Torque, Section S4,5M (SKF)

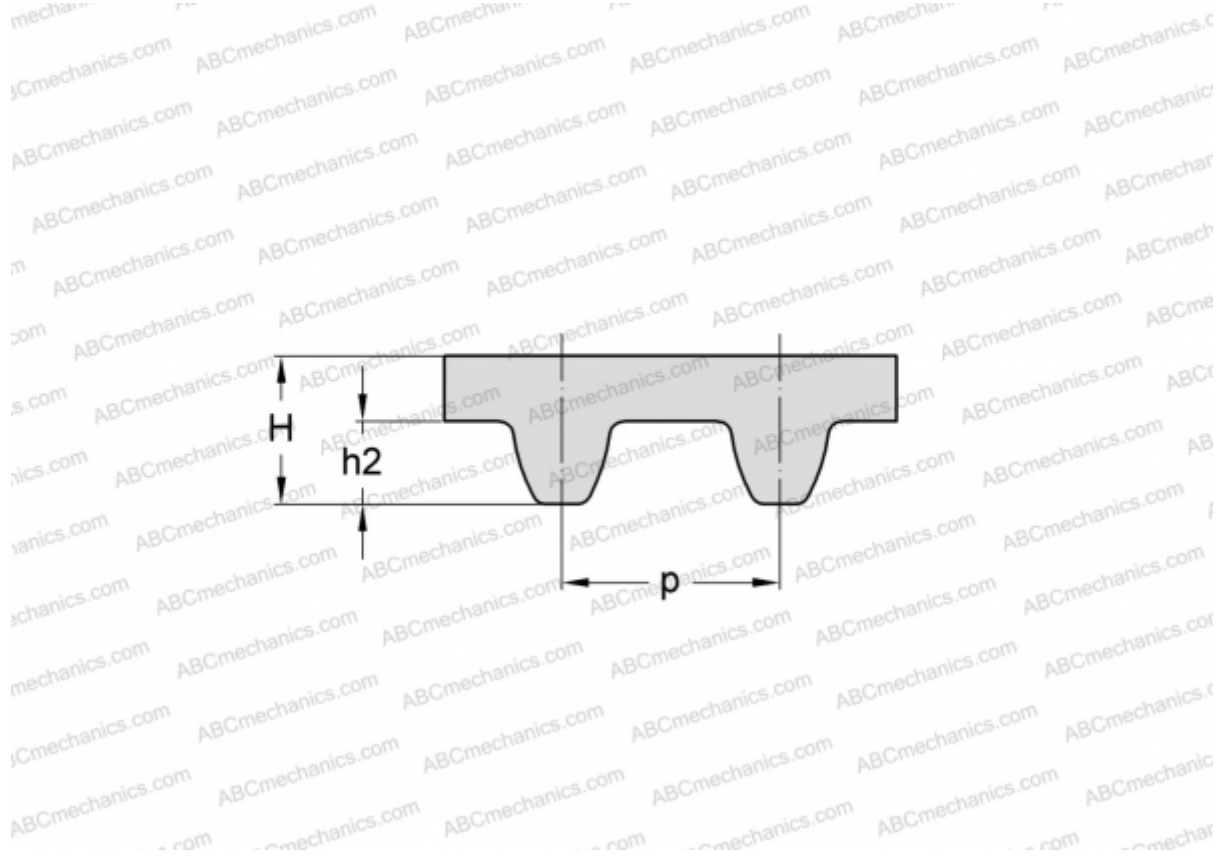

Technical specification

DIMENSIONS, MM

Pitch teeth, p	4,500
Estimated length	180,000
Width, W	9,000
Height, H	2,810
$h2$	1,710
Number of teeth	40

MANUFACTURER

[SKF](#)