

PHG S4.5M-396-15 SKF

HiTD belt

TYPE: Classical timing belts, Oneway, Super Torque, Section S4,5M (SKF)

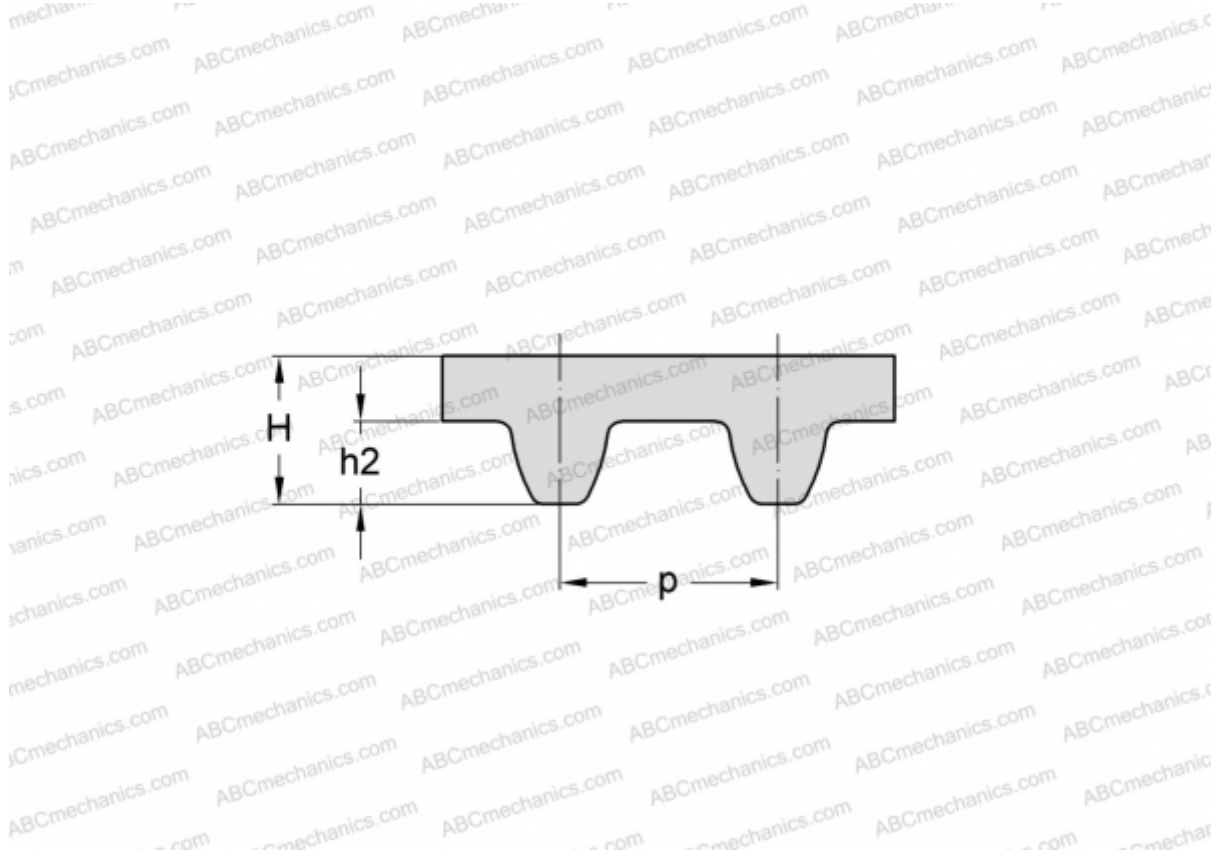

Technical specification

DIMENSIONS, MM

Pitch teeth, p	4,500
Estimated length	396,000
Width, W	15,000
Height, H	2,810
$h2$	1,710
Number of teeth	88

MANUFACTURER

[SKF](#)