

## PHG S4.5M-437-9 SKF

HiTD belt

TYPE: Classical timing belts, Oneway, Super Torque, Section S4,5M (SKF)

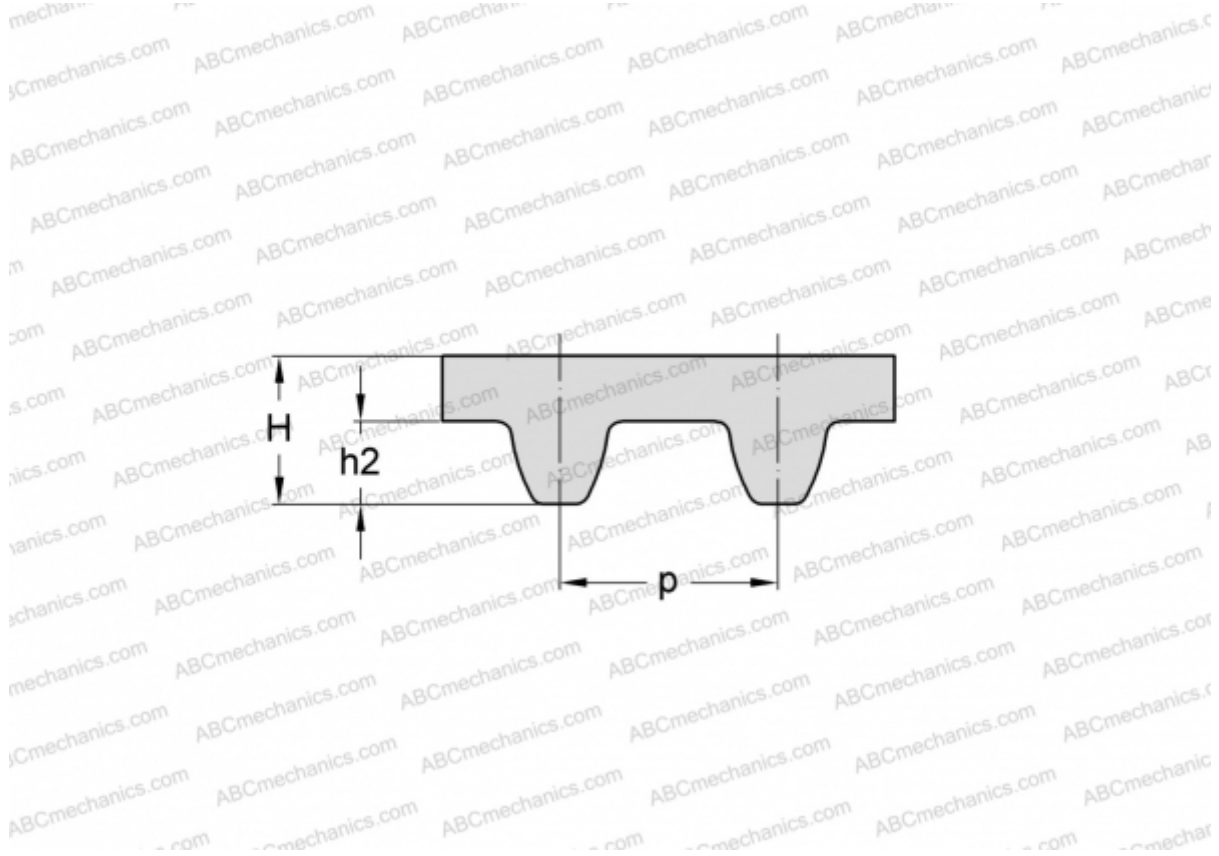

### Technical specification

#### DIMENSIONS, MM

Pitch teeth, $p$	4,500
Estimated length	437,000
Width, $W$	9,000
Height, $H$	2,810
$h2$	1,710
Number of teeth	97

#### MANUFACTURER

[SKF](#)