

## PHG S5M-265-9 SKF

HiTD belt

TYPE: Classical timing belts, Oneway, Super Torque, Section S5M (SKF)

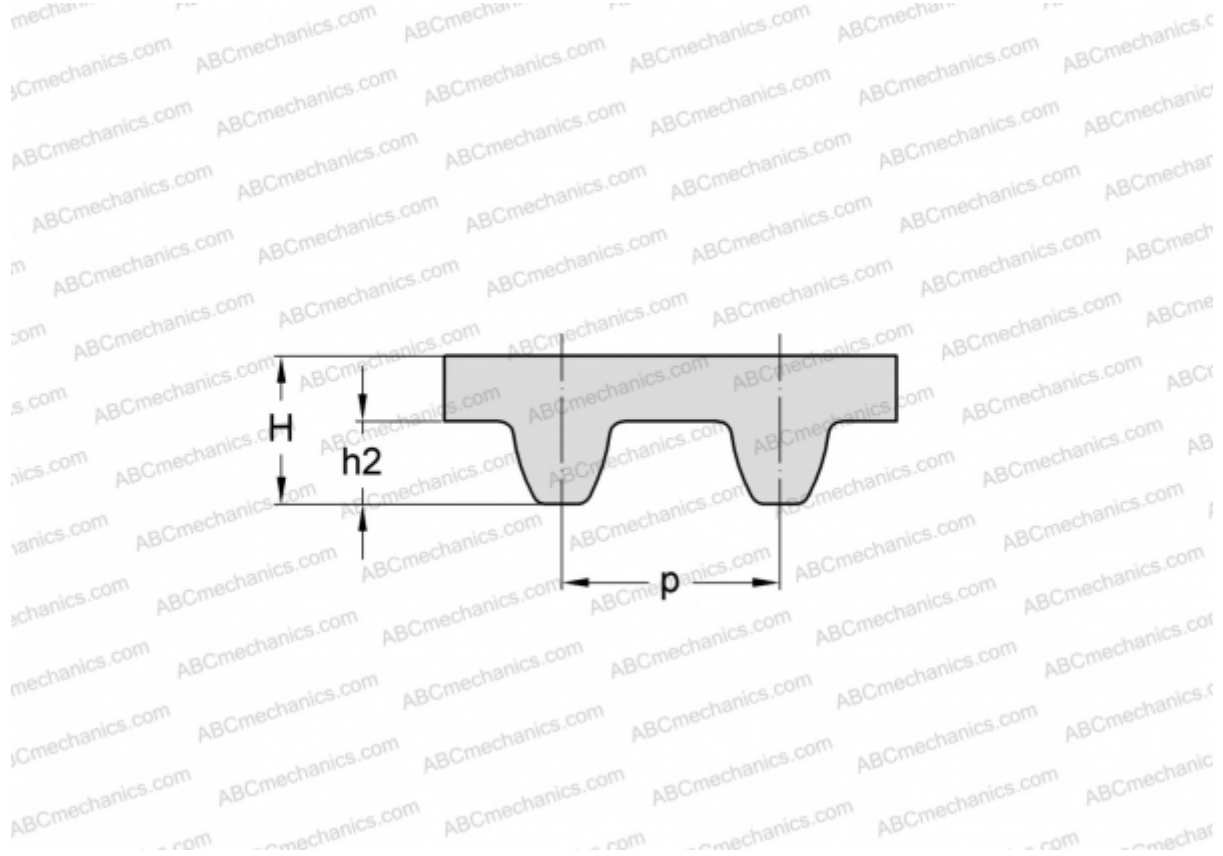

### Technical specification

#### DIMENSIONS, MM

|                  |         |
|------------------|---------|
| Pitch teeth, $p$ | 5,000   |
| Estimated length | 265,000 |
| Width, $W$       | 9,000   |
| Height, $H$      | 3,410   |
| $h2$             | 1,910   |
| Number of teeth  | 53      |

#### MANUFACTURER

[SKF](#)