

## PHG S5M-325-9 SKF

HiTD belt

TYPE: Classical timing belts, Oneway, Super Torque, Section S5M (SKF)

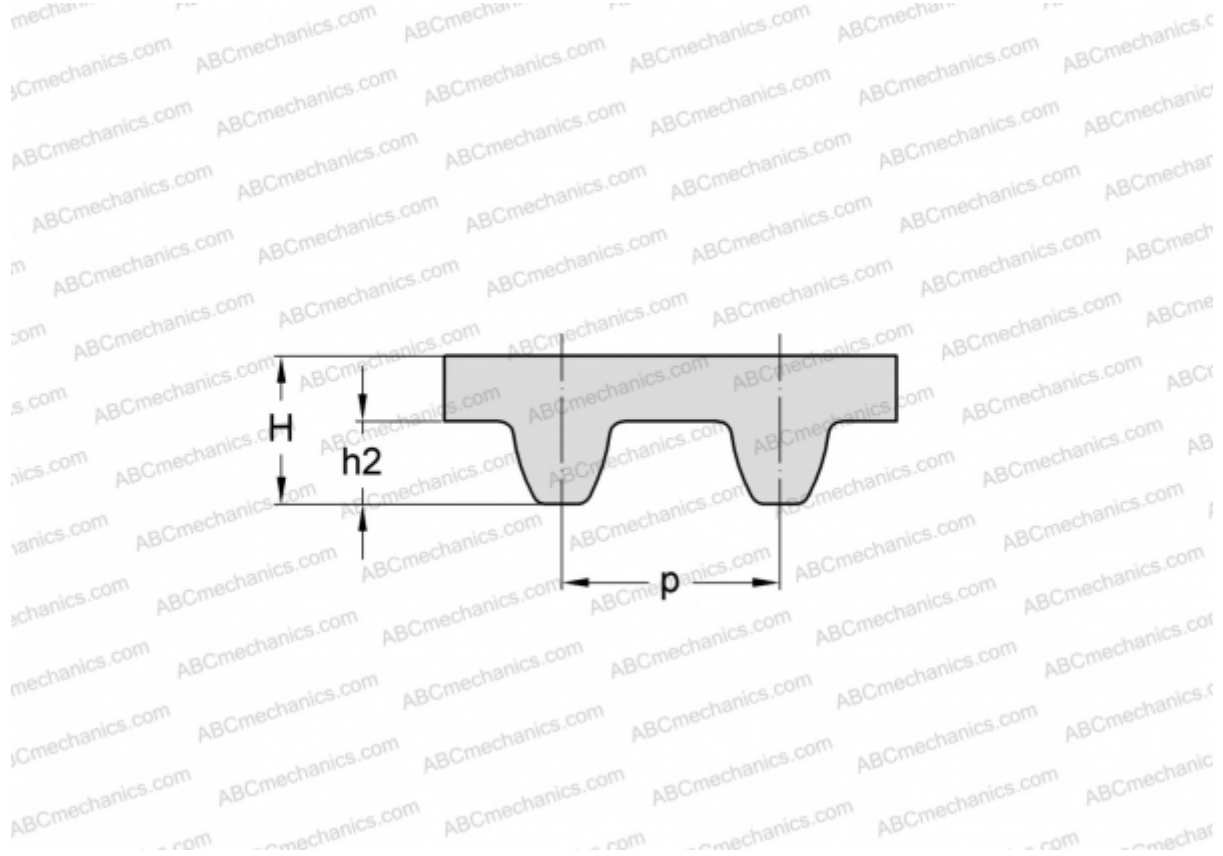

### Technical specification

#### DIMENSIONS, MM

Pitch teeth, $p$	5,000
Estimated length	325,000
Width, $W$	9,000
Height, $H$	3,410
$h2$	1,910
Number of teeth	65

#### MANUFACTURER

[SKF](#)