

## PHG S5M-375-15 SKF

HiTD belt

TYPE: Classical timing belts, Oneway, Super Torque, Section S5M (SKF)

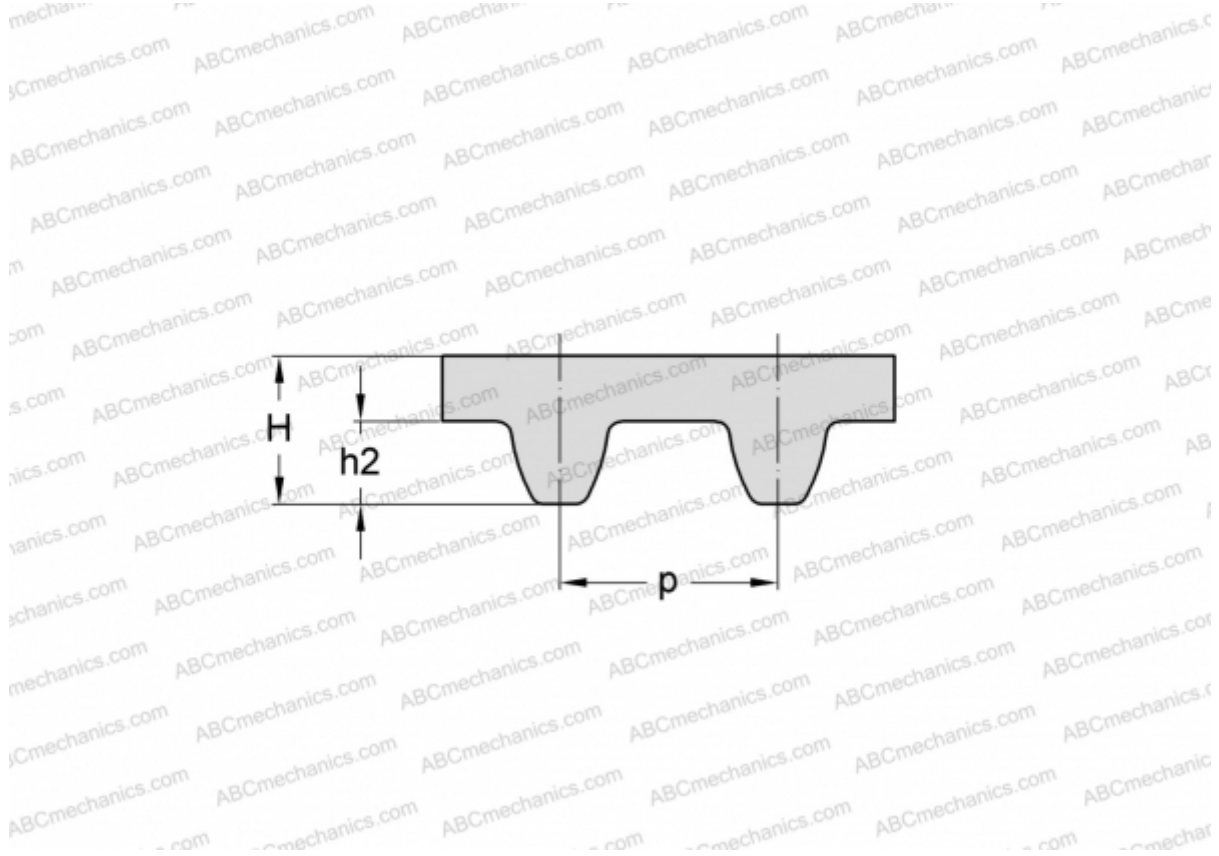

### Technical specification

#### DIMENSIONS, MM

Pitch teeth, $p$	5,000
Estimated length	375,000
Width, $W$	15,000
Height, $H$	3,410
$h_2$	1,910
Number of teeth	75

#### MANUFACTURER

[SKF](#)