

## PHG S5M-525-25 SKF

HiTD belt

TYPE: Classical timing belts, Oneway, Super Torque, Section S5M (SKF)

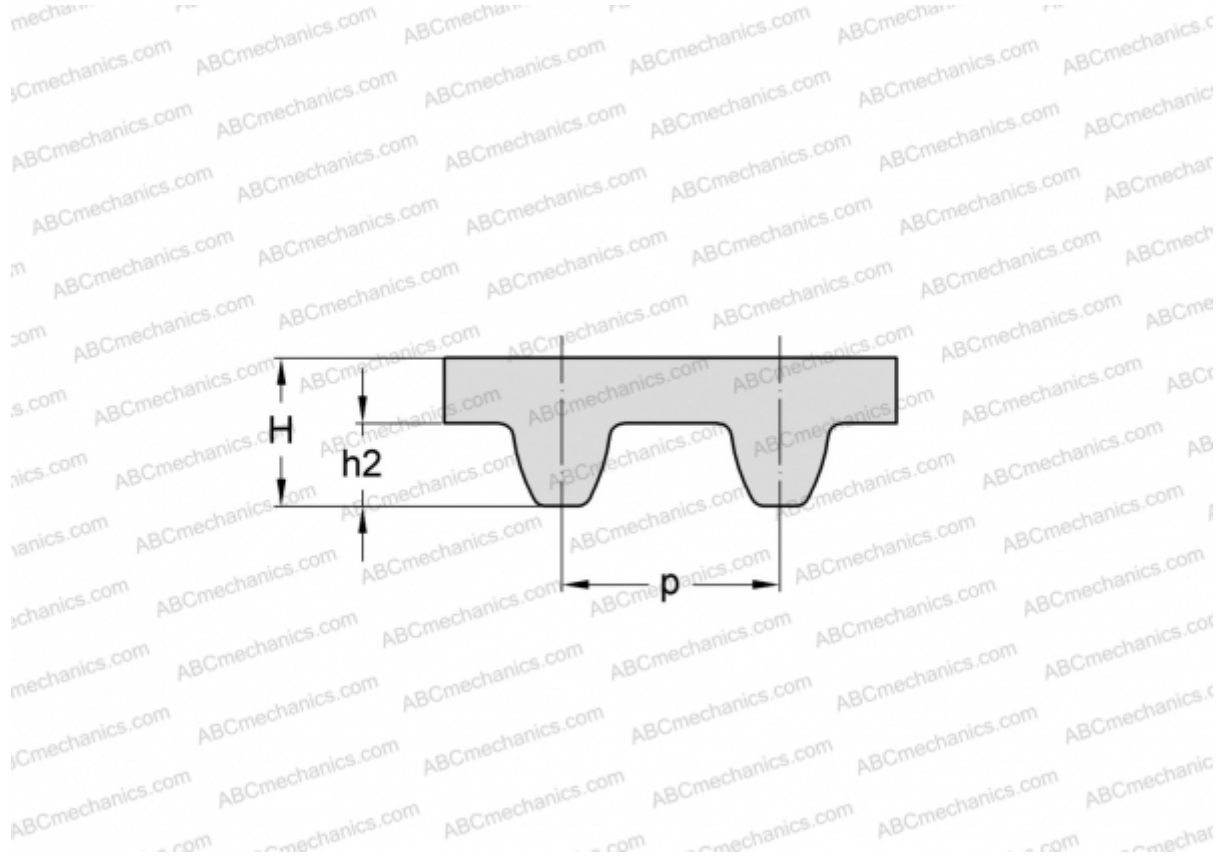

### Technical specification

#### DIMENSIONS, MM

Pitch teeth, $p$	5,000
Estimated length	525,000
Width, $W$	25,000
Height, $H$	3,410
$h2$	1,910
Number of teeth	105

#### MANUFACTURER

[SKF](#)