

PHG S5M-575-25 SKF

HiTD belt

TYPE: Classical timing belts, Oneway, Super Torque, Section S5M (SKF)

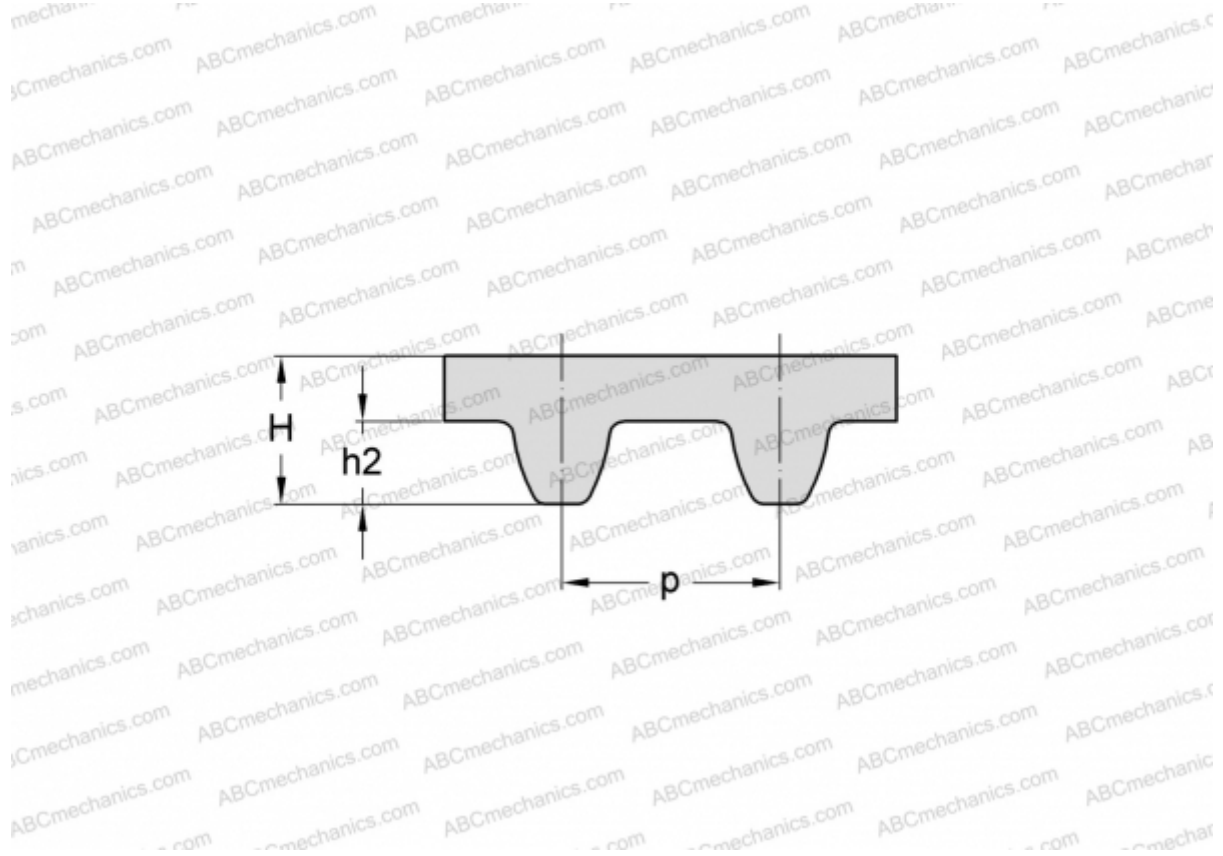

Technical specification

DIMENSIONS, MM

Pitch teeth, p	5,000
Estimated length	575,000
Width, W	25,000
Height, H	3,410
h2	1,910
Number of teeth	115

MANUFACTURER

[SKF](#)