

PHG S5M-600-9 SKF

HiTD belt

TYPE: Classical timing belts, Oneway, Super Torque, Section S5M (SKF)

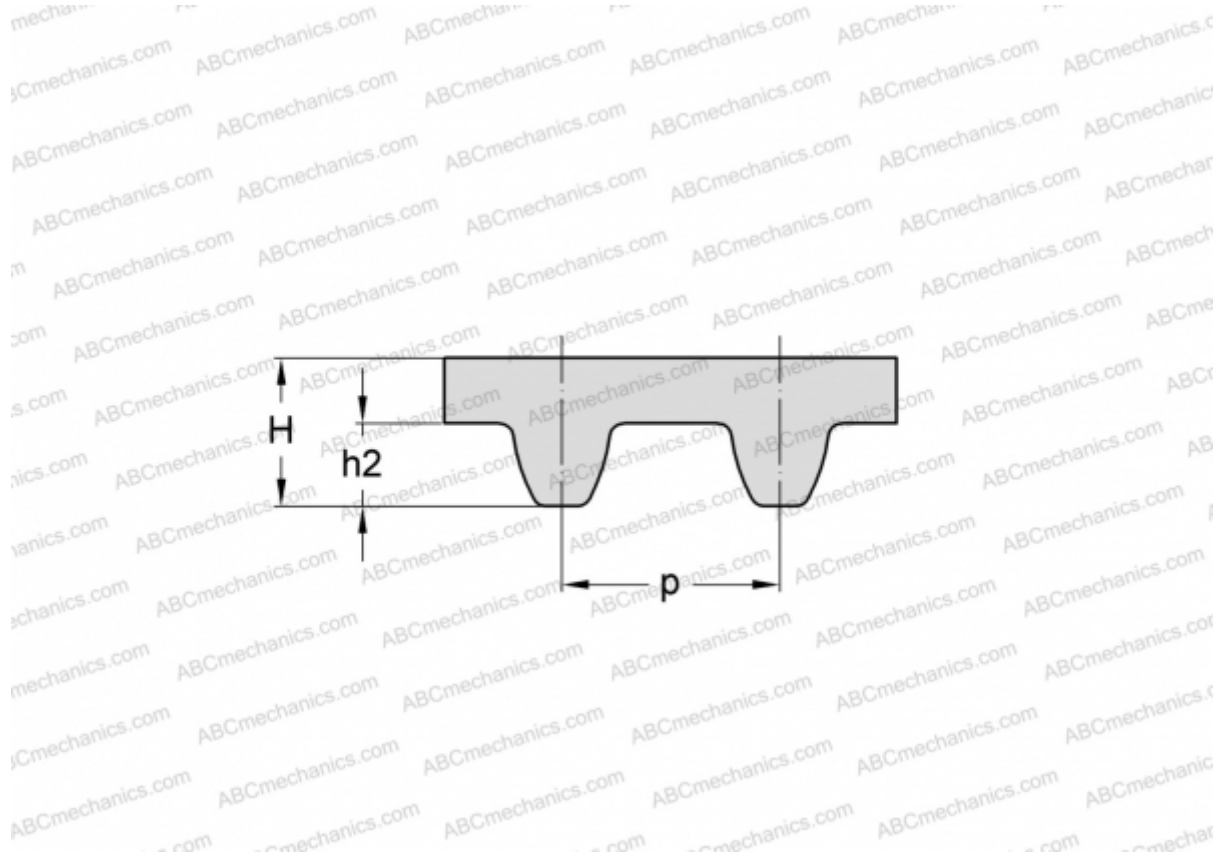

Technical specification

DIMENSIONS, MM

Pitch teeth, p	5,000
Estimated length	600,000
Width, W	9,000
Height, H	3,410
$h2$	1,910
Number of teeth	120

MANUFACTURER

[SKF](#)