

PHG S5M-1000-15 SKF

HiTD belt

TYPE: Classical timing belts, Oneway, Super Torque, Section S5M (SKF)

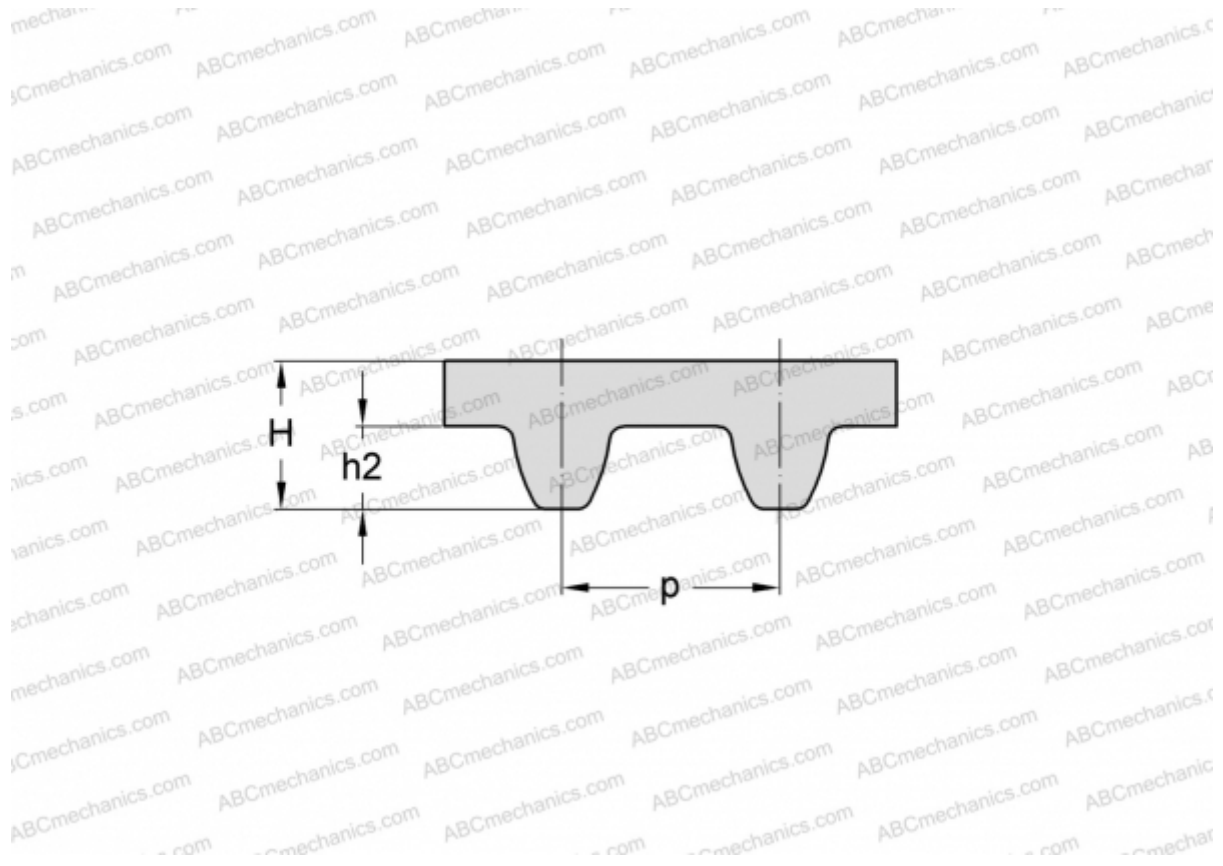

Technical specification

DIMENSIONS, MM

Pitch teeth, p	5,000
Estimated length	1000,000
Width, W	15,000
Height, H	3,410
h2	1,910
Number of teeth	200

MANUFACTURER [SKF](#)