

## PHG S5M-1145-15 SKF

HiTD belt

TYPE: Classical timing belts, Oneway, Super Torque, Section S5M (SKF)

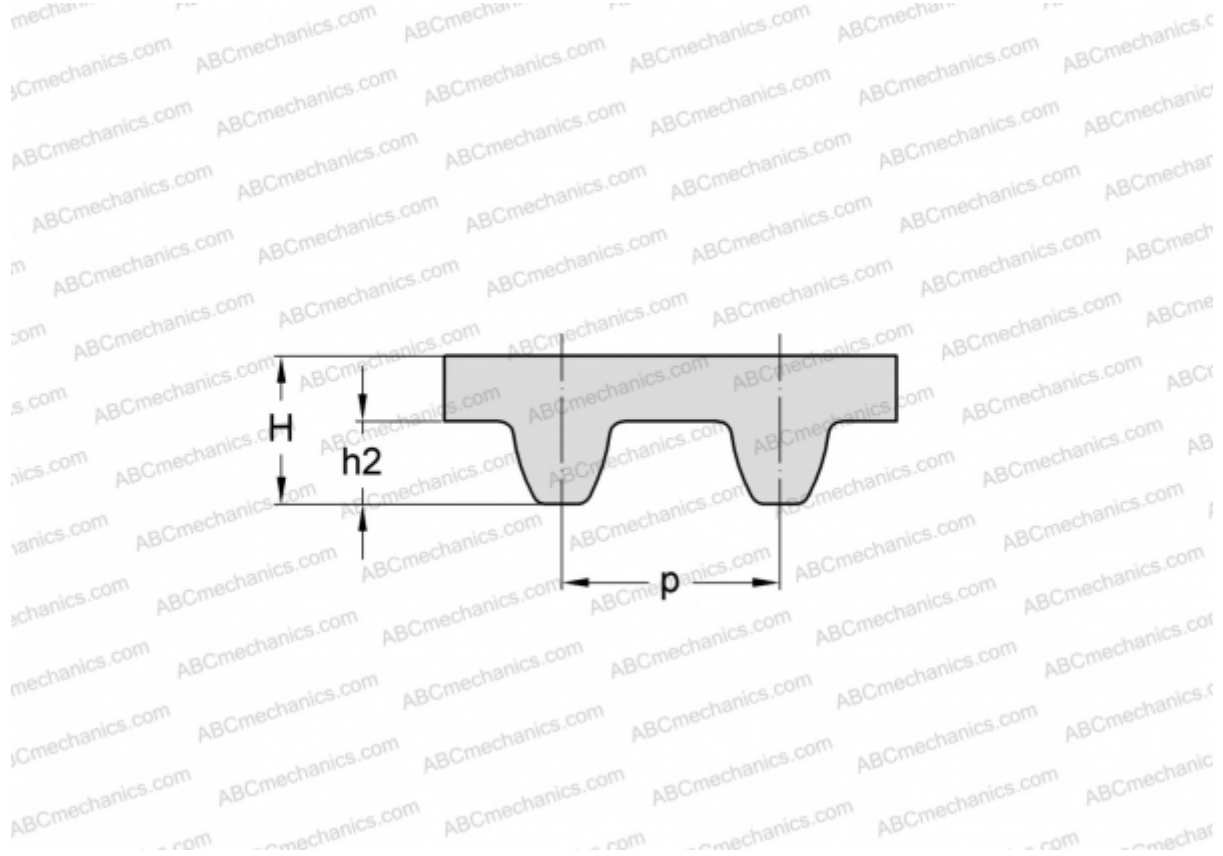

### Technical specification

#### DIMENSIONS, MM

Pitch teeth, $p$	5,000
Estimated length	1145,000
Width, $W$	15,000
Height, $H$	3,410
$h2$	1,910
Number of teeth	229

#### MANUFACTURER

[SKF](#)