

PHG S8M-512-35 SKF

HiTD belt

TYPE: Classical timing belts, Oneway, Super Torque, Section S8M (SKF)

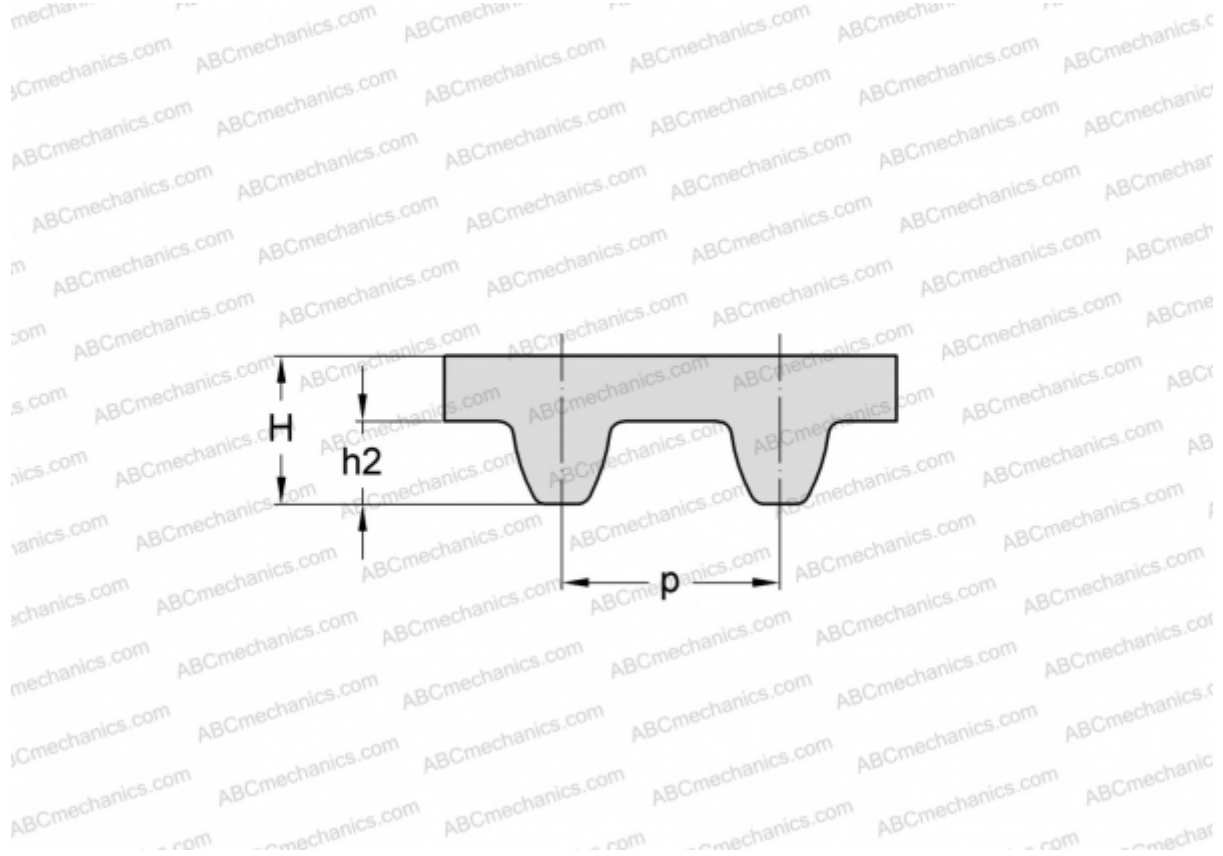

Technical specification

DIMENSIONS, MM

Pitch teeth, p	8,000
Estimated length	512,000
Width, W	35,000
Height, H	5,300
h2	3,050
Number of teeth	64

MANUFACTURER

[SKF](#)