

PHG S8M-728-50 SKF

HiTD belt

TYPE: Classical timing belts, Oneway, Super Torque, Section S8M (SKF)

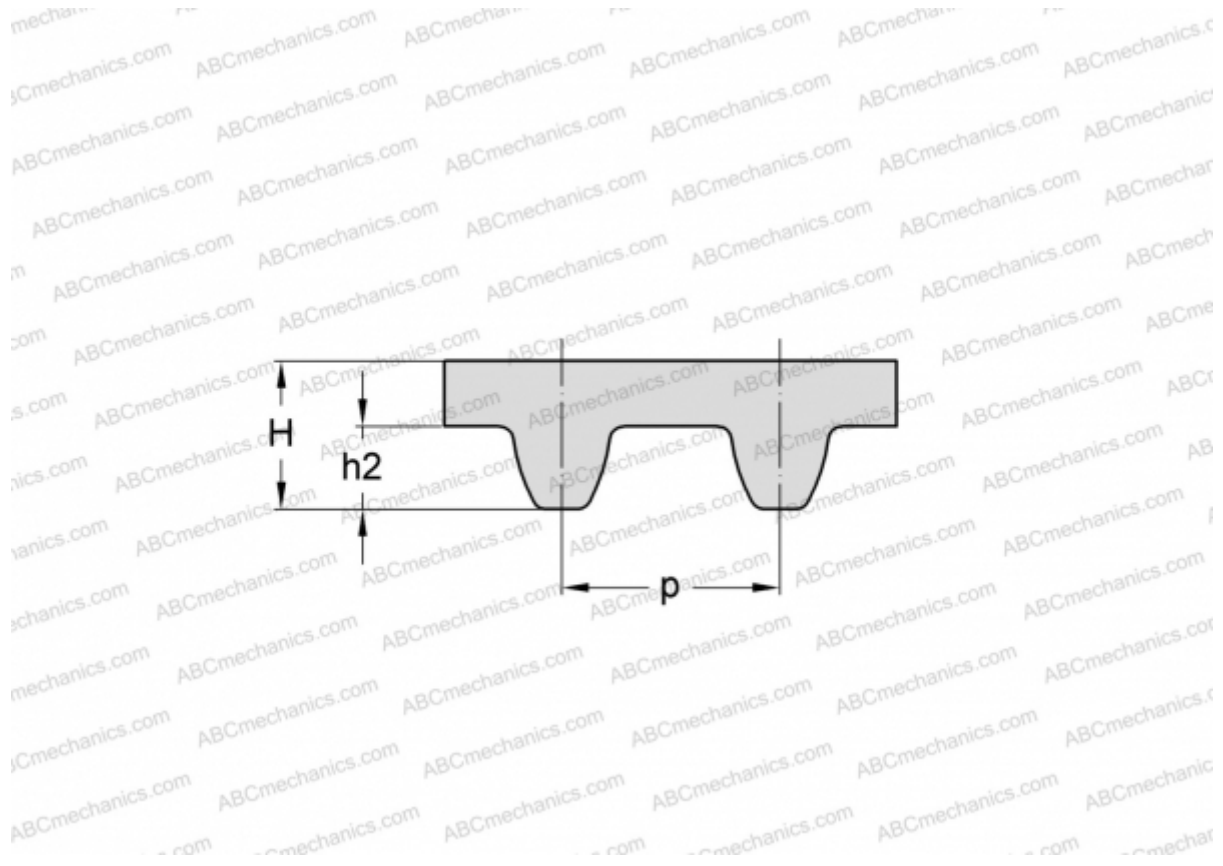

Technical specification

DIMENSIONS, MM

Pitch teeth, p	8,000
Estimated length	728,000
Width, W	50,000
Height, H	5,300
h2	3,050
Number of teeth	91

MANUFACTURER

[SKF](#)