

PHG S8M-960-20 SKF

HiTD belt

TYPE: Classical timing belts, Oneway, Super Torque, Section S8M (SKF)

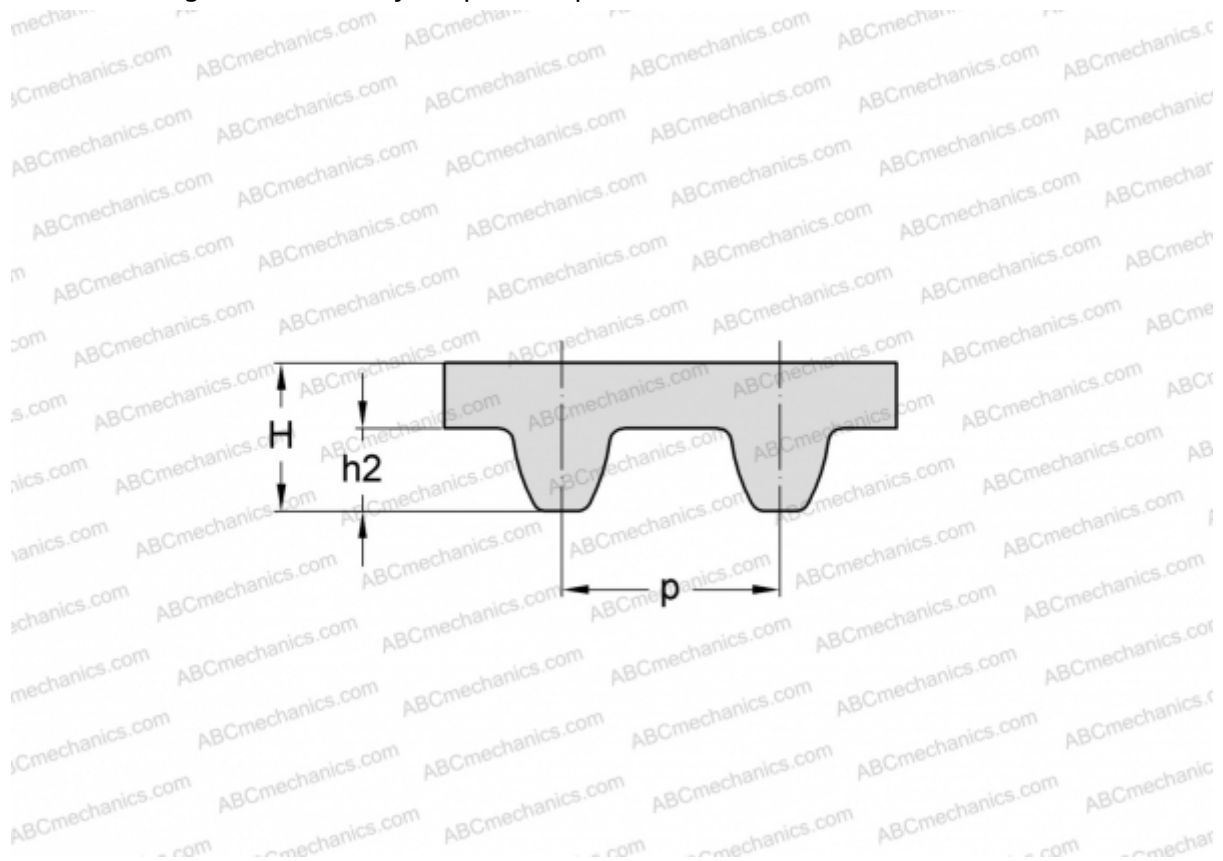

Technical specification

DIMENSIONS, MM

| | |
|------------------|---------|
| Pitch teeth, p | 8,000 |
| Estimated length | 960,000 |
| Width, W | 20,000 |
| Height, H | 5,300 |
| h2 | 3,050 |
| Number of teeth | 120 |

MANUFACTURER

[SKF](#)