

## PHG S8M-1296-85 SKF

HiTD belt

TYPE: Classical timing belts, Oneway, Super Torque, Section S8M (SKF)

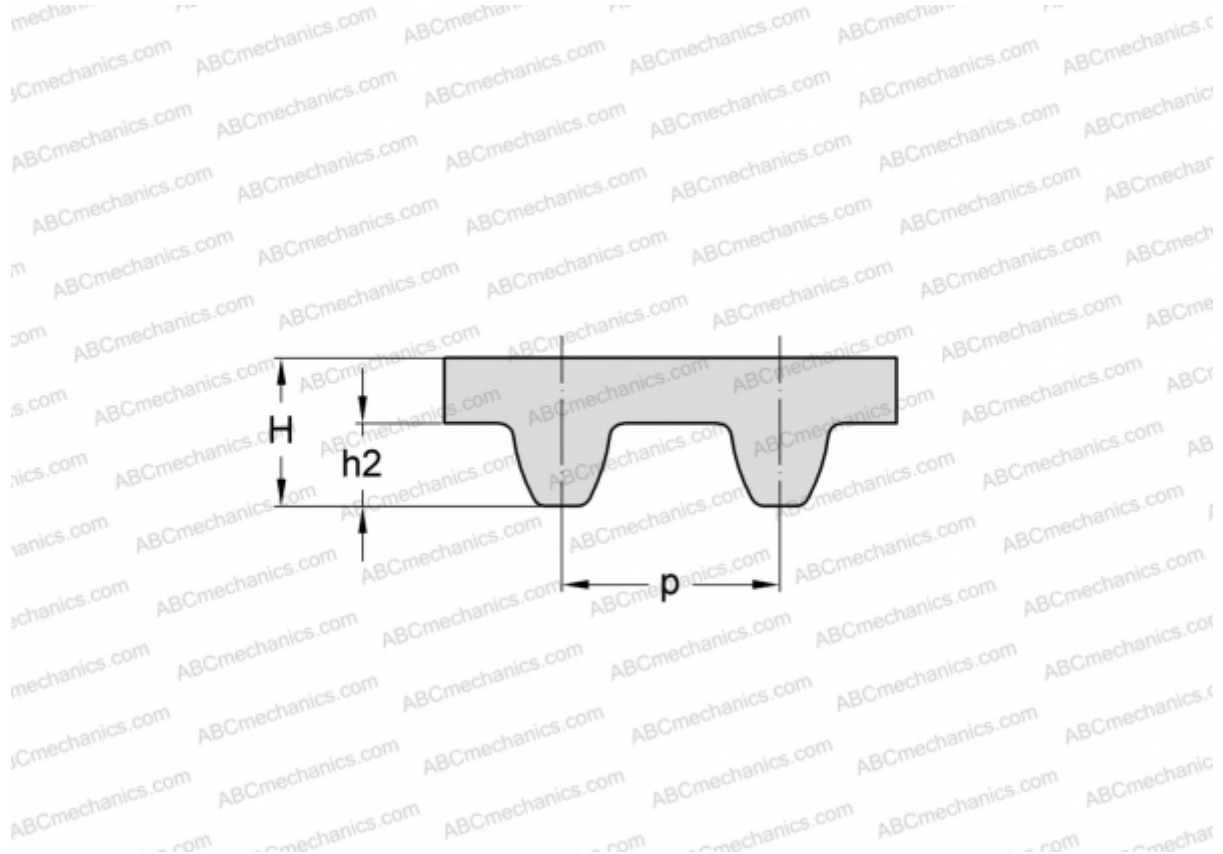

### Technical specification

#### DIMENSIONS, MM

Pitch teeth, $p$	8,000
Estimated length	1296,000
Width, $W$	85,000
Height, $H$	5,300
$h2$	3,050
Number of teeth	162

#### MANUFACTURER

[SKF](#)