

## PHG S8M-1400-35 SKF

HiTD belt

TYPE: Classical timing belts, Oneway, Super Torque, Section S8M (SKF)

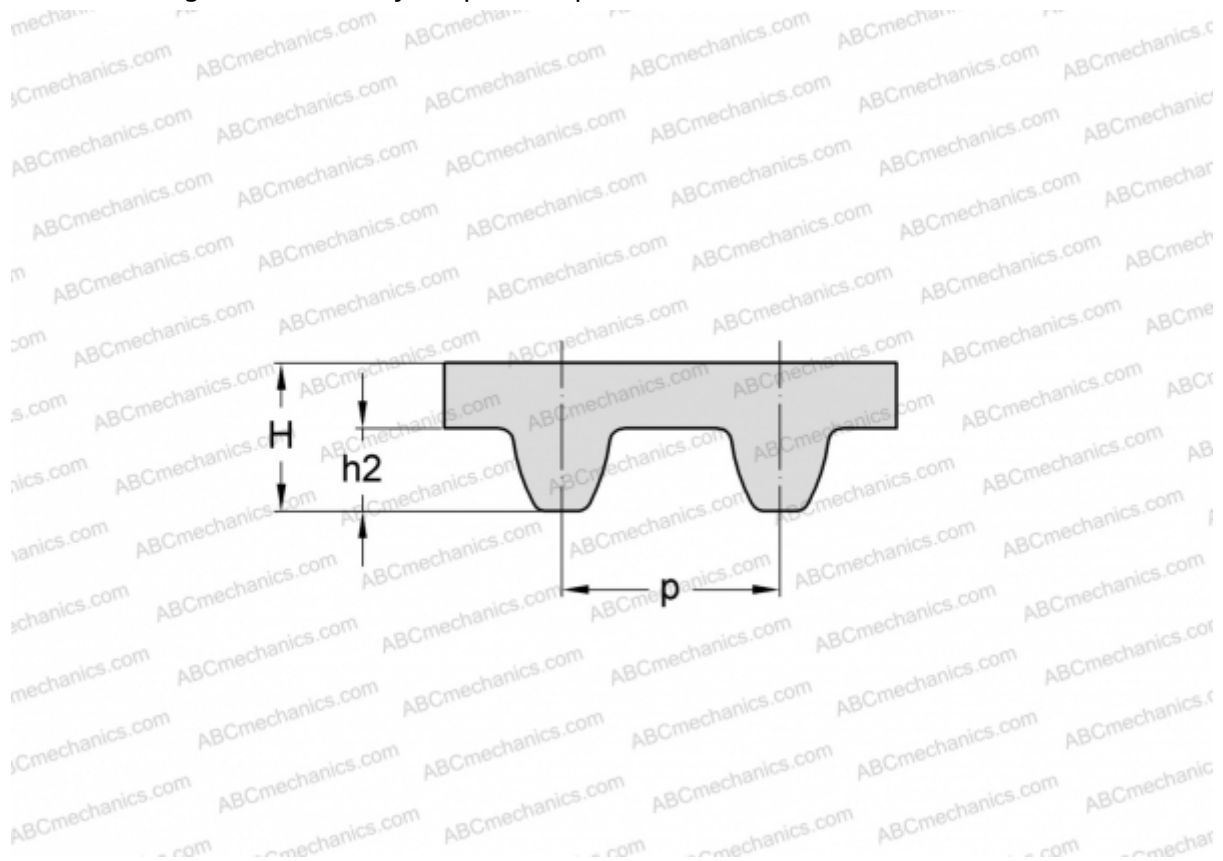

### Technical specification

#### DIMENSIONS, MM

|                  |          |
|------------------|----------|
| Pitch teeth, $p$ | 8,000    |
| Estimated length | 1400,000 |
| Width, $W$       | 35,000   |
| Height, $H$      | 5,300    |
| $h2$             | 3,050    |
| Number of teeth  | 175      |

#### MANUFACTURER

[SKF](#)