

PHG S8M-1424-85 SKF

HiTD belt

TYPE: Classical timing belts, Oneway, Super Torque, Section S8M (SKF)

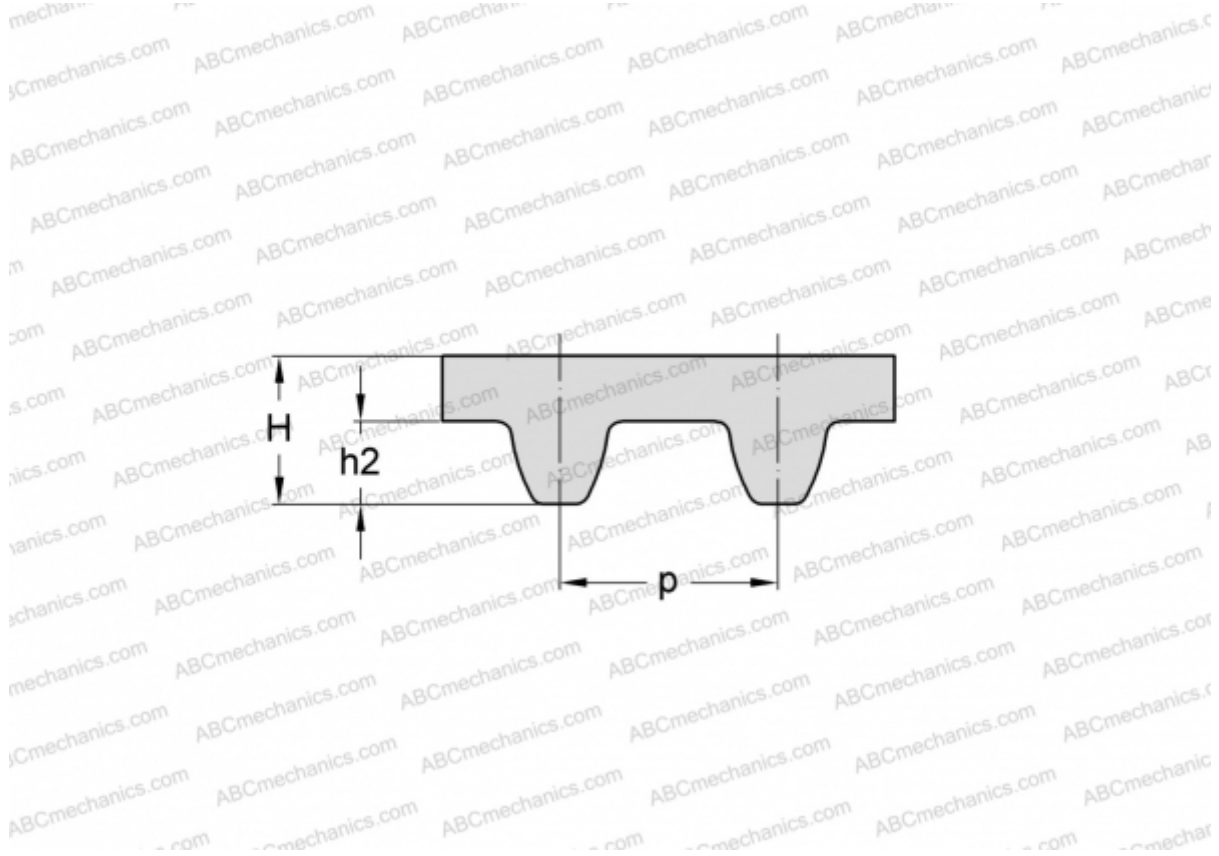

Technical specification

DIMENSIONS, MM

Pitch teeth, p	8,000
Estimated length	1424,000
Width, W	85,000
Height, H	5,300
$h2$	3,050
Number of teeth	178

MANUFACTURER

[SKF](#)