

## PHG S8M-2496-35 SKF

HiTD belt

TYPE: Classical timing belts, Oneway, Super Torque, Section S8M (SKF)

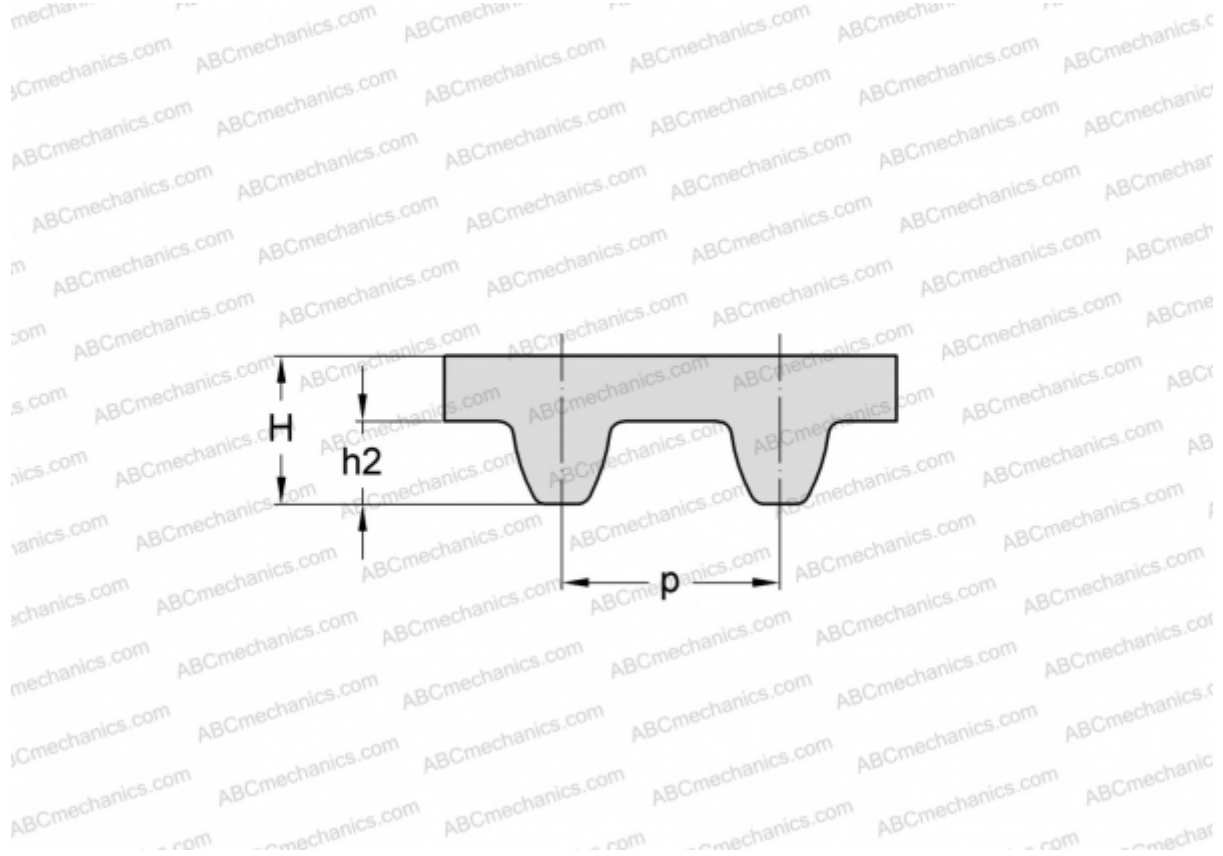

### Technical specification

#### DIMENSIONS, MM

Pitch teeth, $p$	8,000
Estimated length	2496,000
Width, $W$	35,000
Height, $H$	5,300
$h_2$	3,050
Number of teeth	312

#### MANUFACTURER

[SKF](#)