

PHG S14M-714-40 SKF

HiTD belt

TYPE: Classical timing belts, Oneway, Super Torque, Section S14M (SKF)

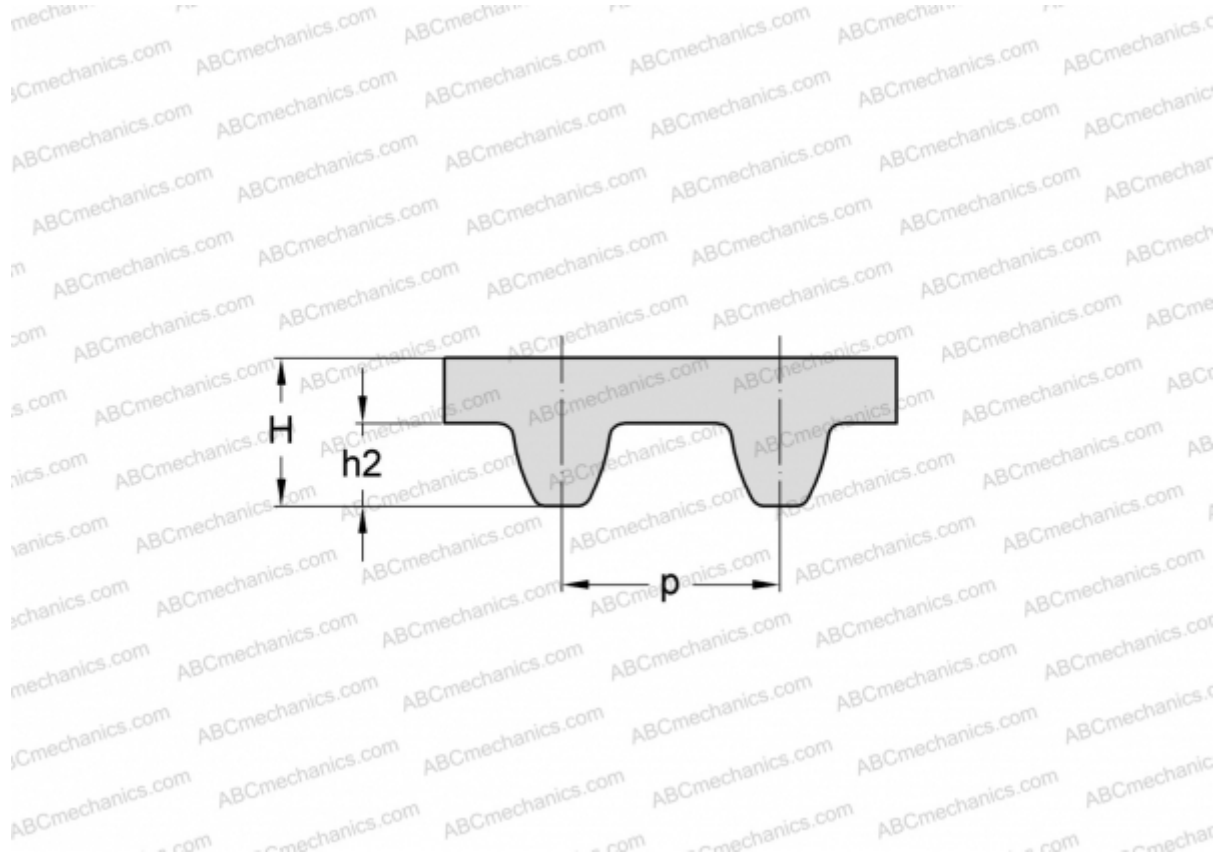

Technical specification

DIMENSIONS, MM

Pitch teeth, p	14,000
Estimated length	714,000
Width, W	40,000
Height, H	10,200
$h2$	5,300
Number of teeth	51

MANUFACTURER

[SKF](#)