

PHG S14M-1652-85 SKF

HiTD belt

TYPE: Classical timing belts, Oneway, Super Torque, Section S14M (SKF)

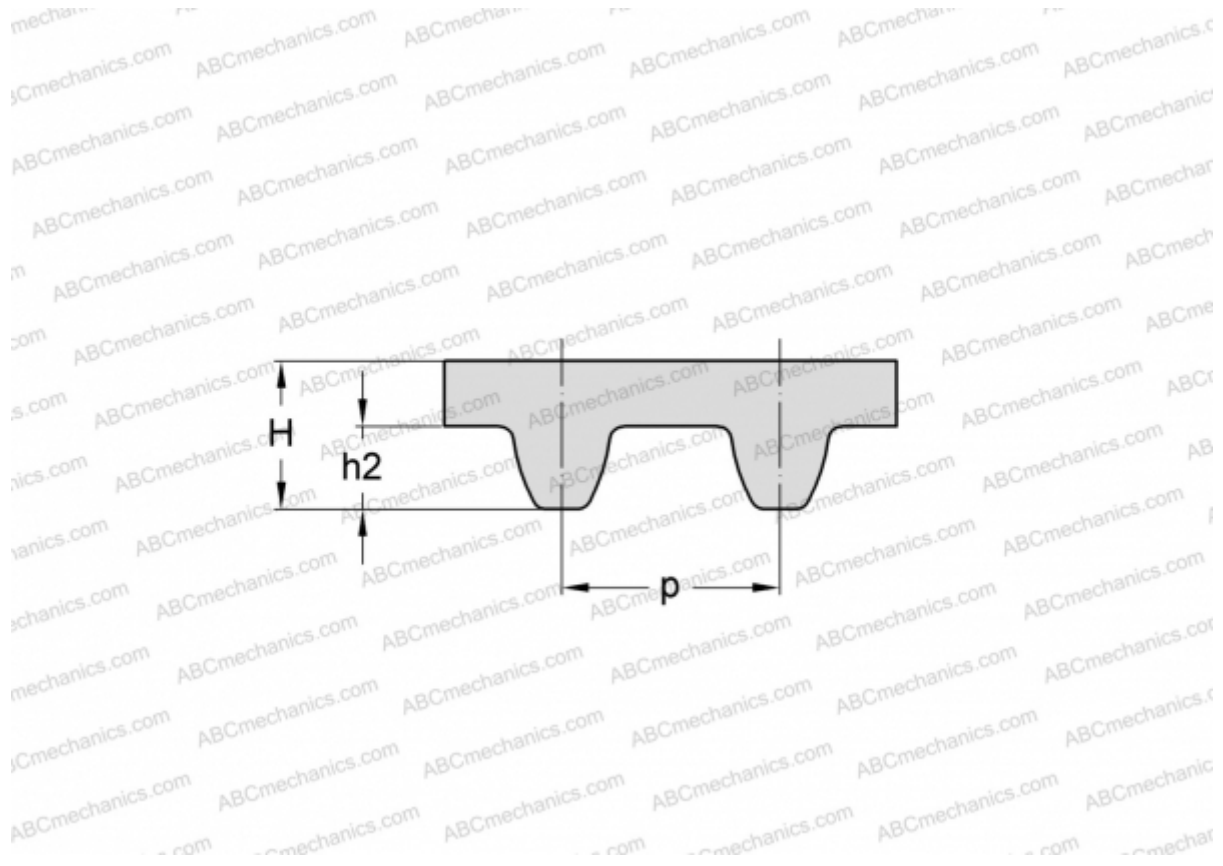

Technical specification

DIMENSIONS, MM

| | |
|------------------|----------|
| Pitch teeth, p | 14,000 |
| Estimated length | 1652,000 |
| Width, W | 85,000 |
| Height, H | 10,200 |
| $h2$ | 5,300 |
| Number of teeth | 118 |

MANUFACTURER [SKF](#)