

## PHG S14M-2380-85 SKF

HiTD belt

TYPE: Classical timing belts, Oneway, Super Torque, Section S14M (SKF)

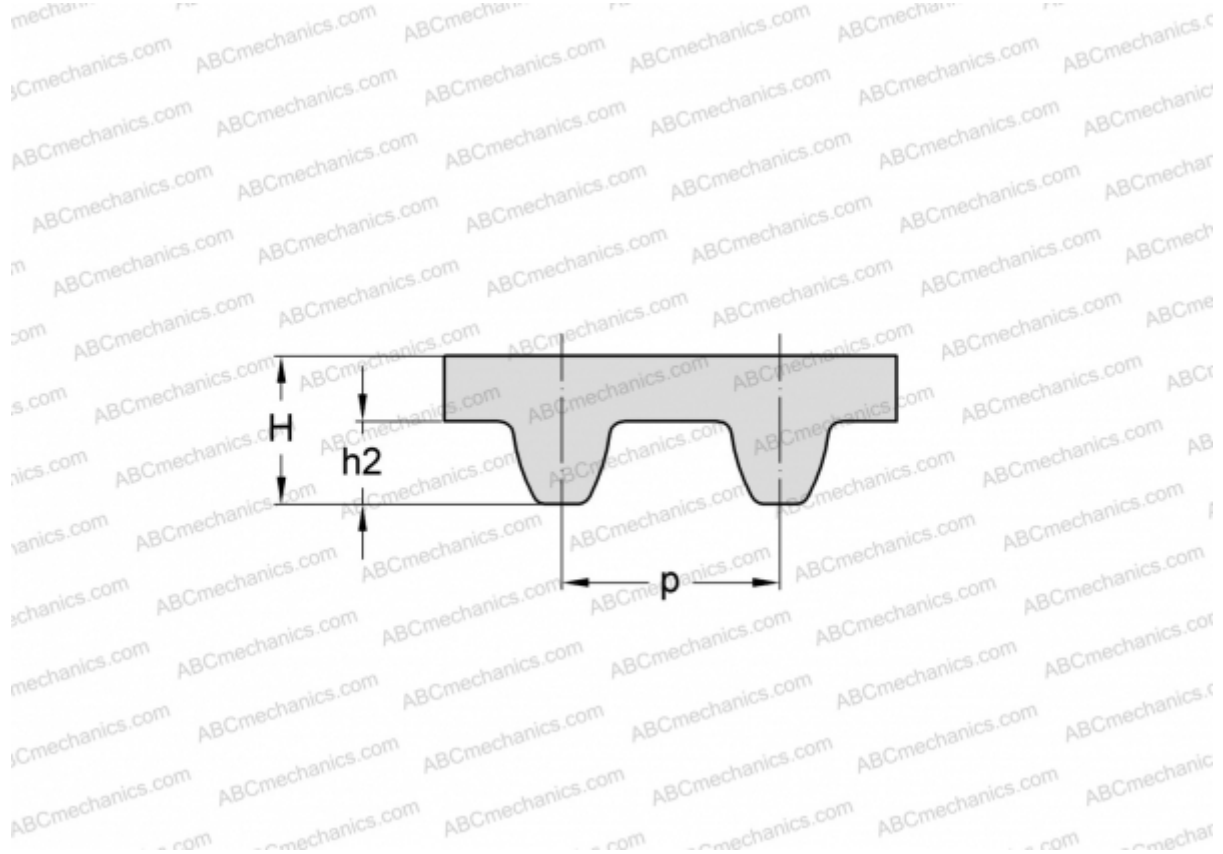

### Technical specification

#### DIMENSIONS, MM

Pitch teeth, $p$	14,000
Estimated length	2380,000
Width, $W$	85,000
Height, $H$	10,200
$h2$	5,300
Number of teeth	170

#### MANUFACTURER

[SKF](#)