

PHG S14M-2590-170 SKF

HiTD belt

TYPE: Classical timing belts, Oneway, Super Torque, Section S14M (SKF)

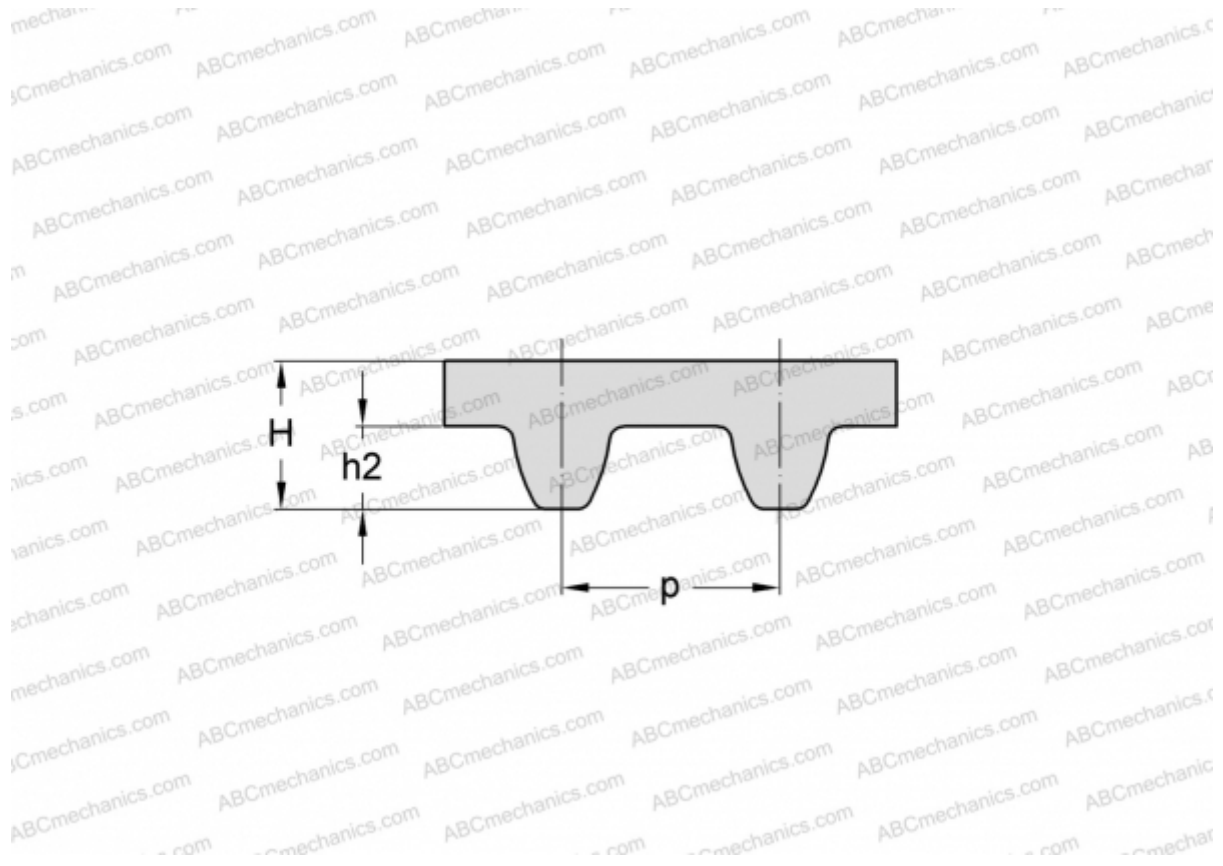

Technical specification

DIMENSIONS, MM

Pitch teeth, p	14,000
Estimated length	2590,000
Width, W	170,000
Height, H	10,200
$h2$	5,300
Number of teeth	185

MANUFACTURER [SKF](#)