

## PHG S14M-2800-55 SKF

HiTD belt

TYPE: Classical timing belts, Oneway, Super Torque, Section S14M (SKF)

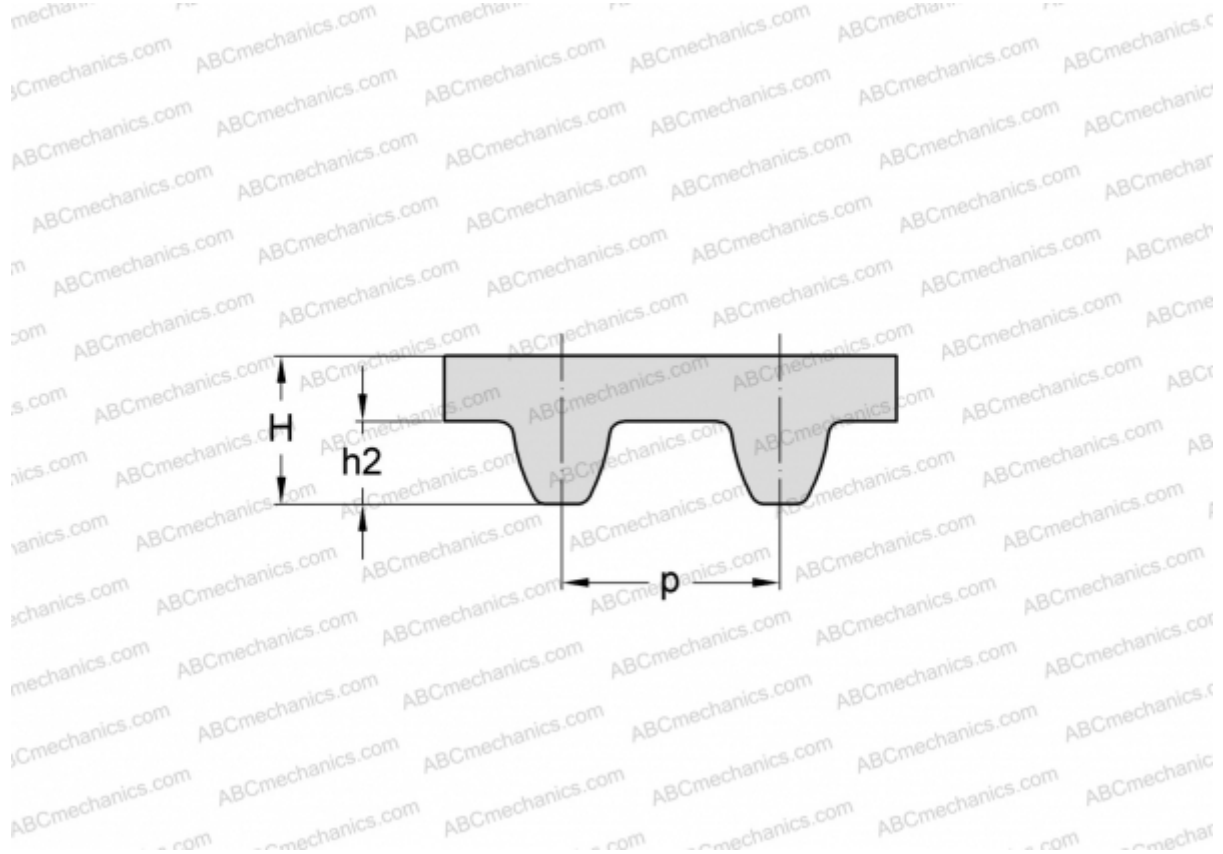

### Technical specification

#### DIMENSIONS, MM

Pitch teeth, p	14,000
Estimated length	2800,000
Width, W	55,000
Height, H	10,200
h2	5,300
Number of teeth	200

**MANUFACTURER** [SKF](#)