

## PHG T2.5-230-10 SKF

Metric timing belt, T section

TYPE: Classical timing belts, Oneway, Metric, Section T2.5 (SKF)

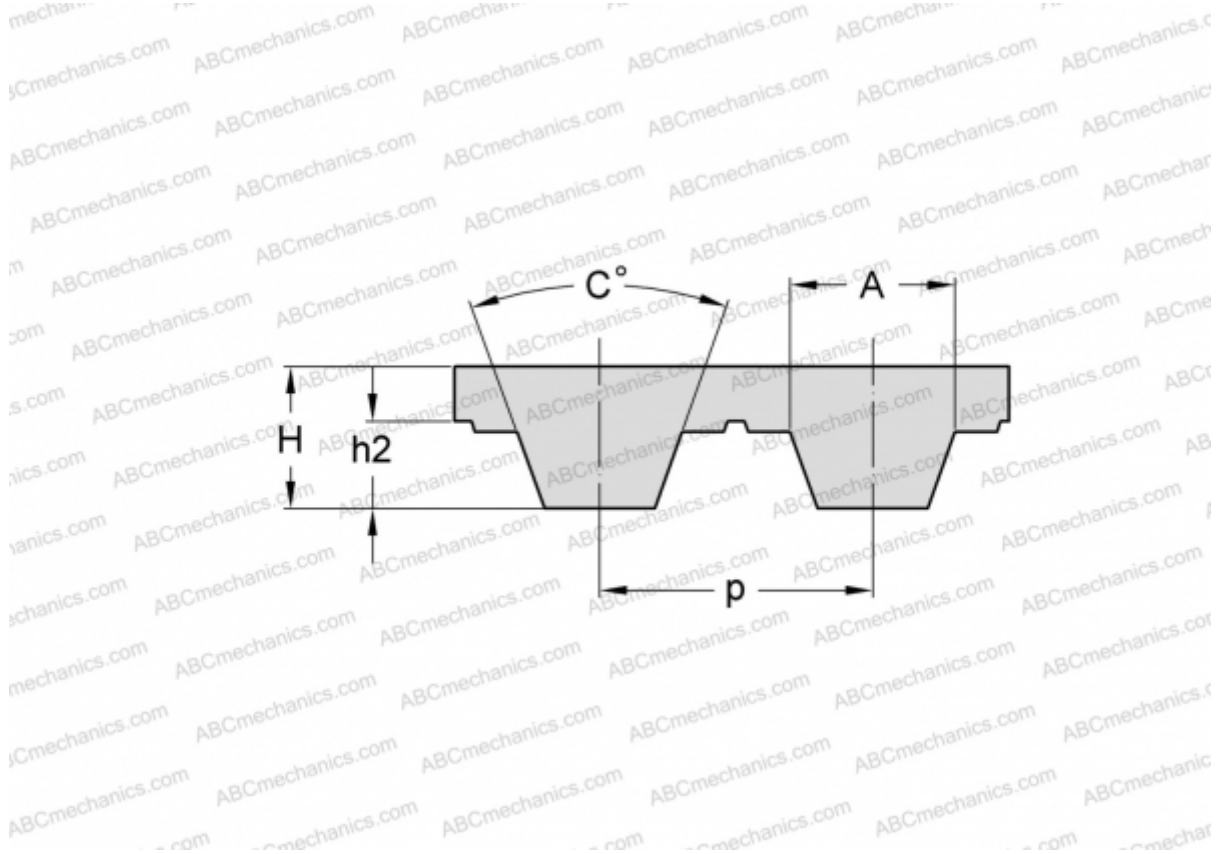

### Technical specification

#### DIMENSIONS, MM

Pitch teeth, $p$	2,500
Estimated length	230,000
Width, $W$	10,000
Height, $H$	1,300
$C$	40,000
$h_2$	0,700
$A$	1,500
Number of teeth	92

#### MANUFACTURER

[SKF](#)