

PHG T2.5-245-4 SKF

Metric timing belt, T section

TYPE: Classical timing belts, Oneway, Metric, Section T2.5 (SKF)

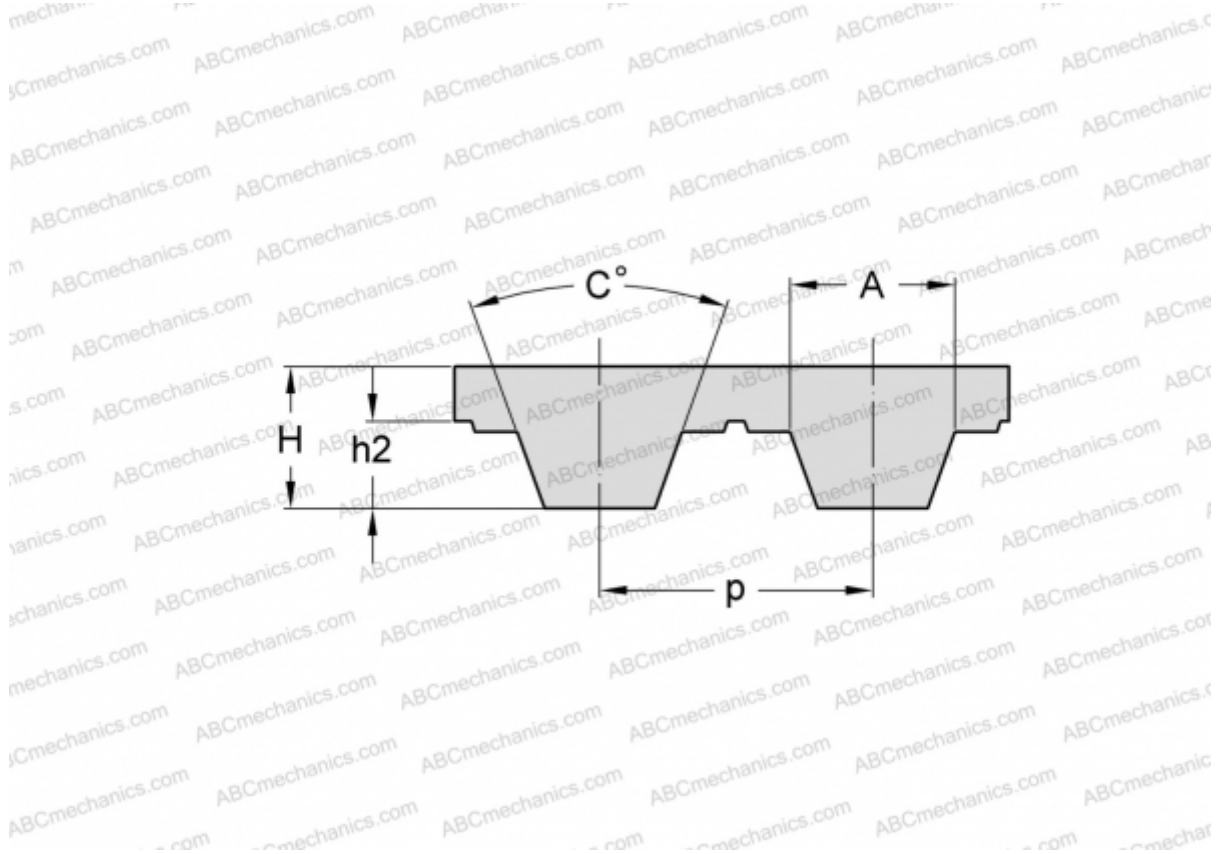

Technical specification

DIMENSIONS, MM

Pitch teeth, p	2,500
Estimated length	245,000
Width, W	4,000
Height, H	1,300
C	40,000
h_2	0,700
A	1,500
Number of teeth	98

MANUFACTURER

[SKF](#)