

PHG T2.5-330-4 SKF

Metric timing belt, T section

TYPE: Classical timing belts, Oneway, Metric, Section T2.5 (SKF)

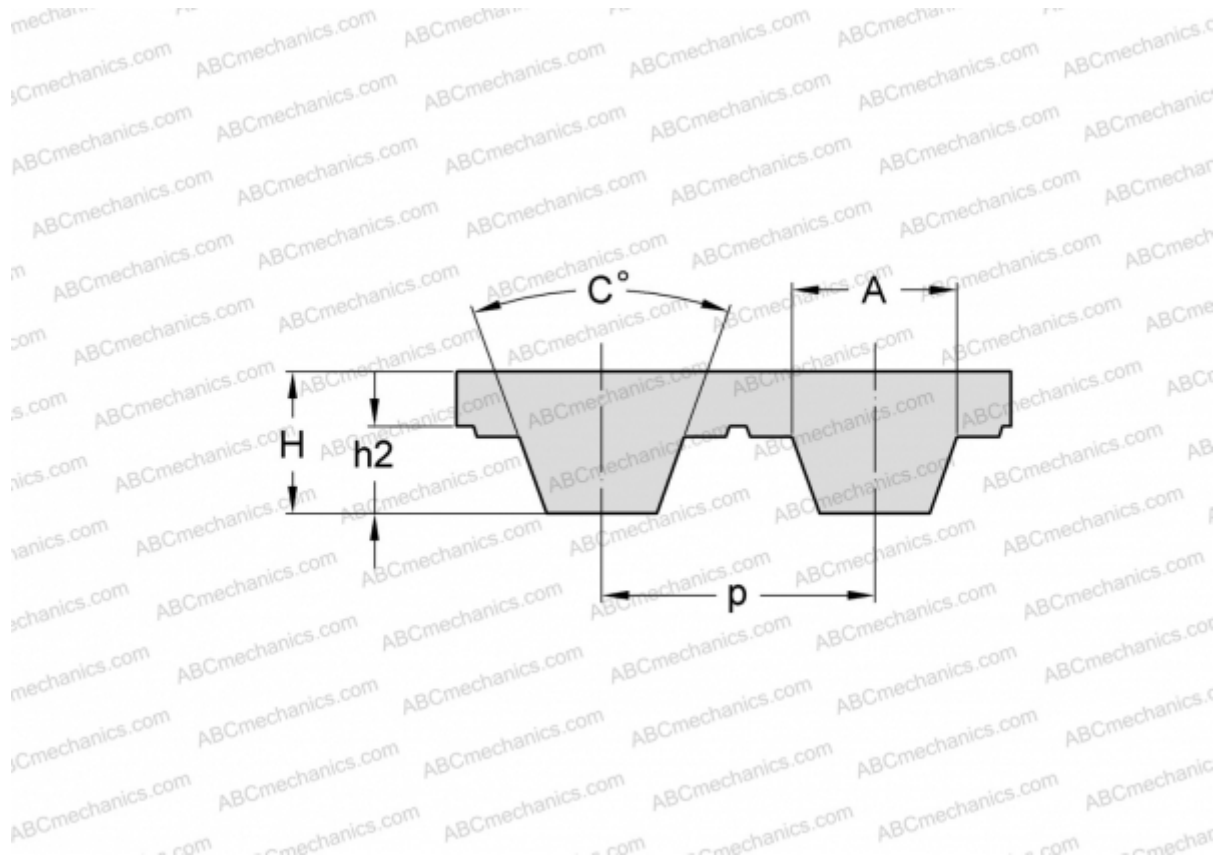

Technical specification

DIMENSIONS, MM

| | |
|------------------|---------|
| Pitch teeth, p | 2,500 |
| Estimated length | 330,000 |
| Width, W | 4,000 |
| Height, H | 1,300 |
| C | 40,000 |
| h2 | 0,700 |
| A | 1,500 |
| Number of teeth | 132 |

MANUFACTURER [SKF](#)