

## PHG T2.5-500-6 SKF

Metric timing belt, T section

TYPE: Classical timing belts, Oneway, Metric, Section T2.5 (SKF)

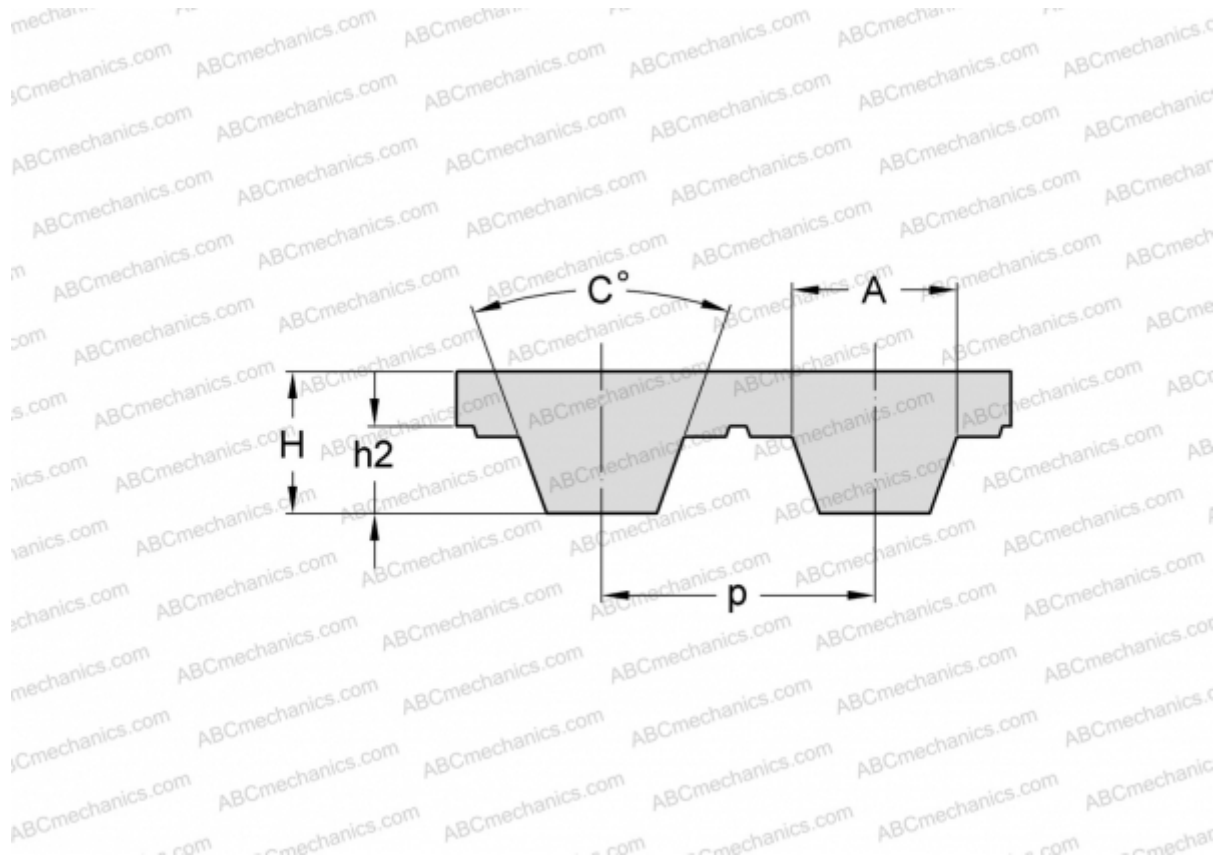

### Technical specification

#### DIMENSIONS, MM

Pitch teeth, p	2,500
Estimated length	500,000
Width, W	6,000
Height, H	1,300
C	40,000
h2	0,700
A	1,500
Number of teeth	200

**MANUFACTURER** [SKF](#)