

## PHG T5-115-25 SKF

Metric timing belt, T section

TYPE: Classical timing belts, Oneway, Metric, Section T5 (SKF)

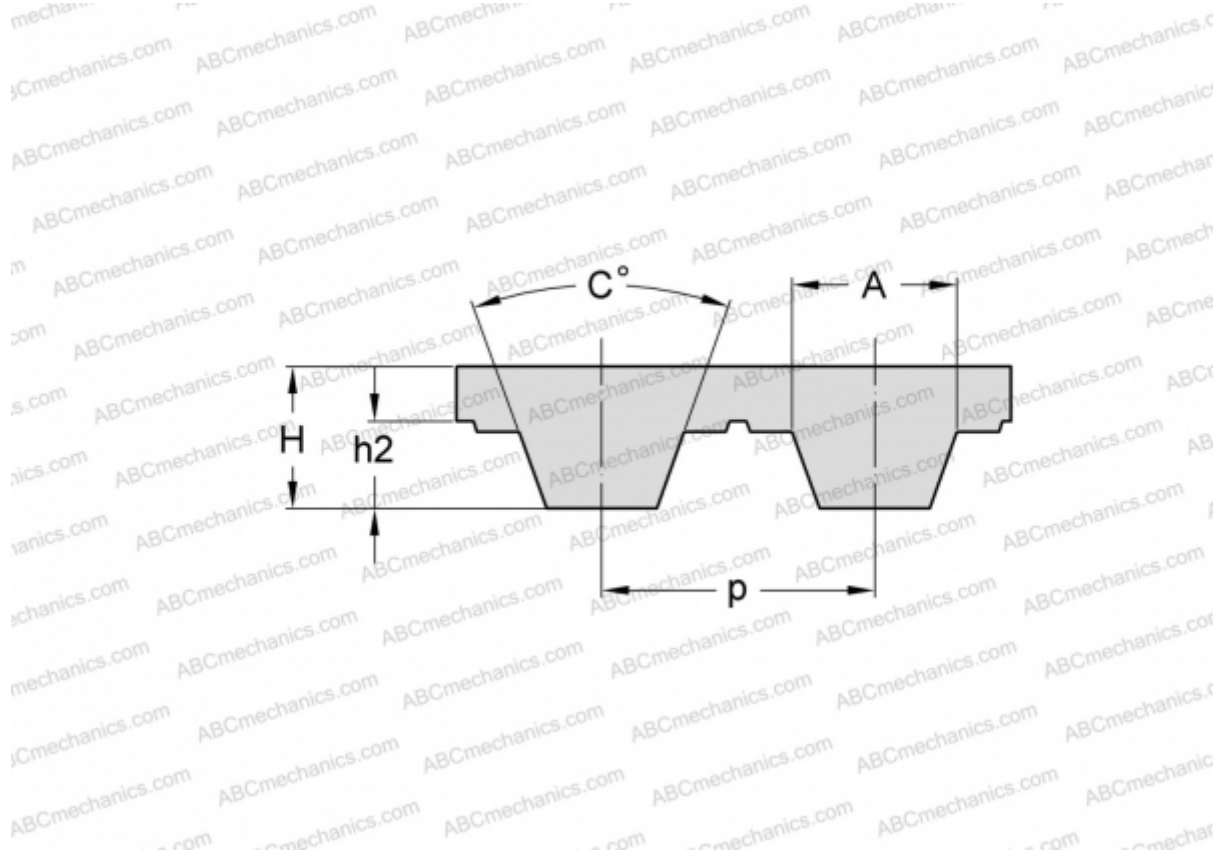

### Technical specification

#### DIMENSIONS, MM

Pitch teeth, $p$	5,000
Estimated length	115,000
Height, $H$	2,200
$C$	40,000
$h_2$	1,200
$A$	2,650
Number of teeth	23

#### MANUFACTURER

[SKF](#)