

## PHG T5-800-10 SKF

Metric timing belt, T section

TYPE: Classical timing belts, Oneway, Metric, Section T5 (SKF)

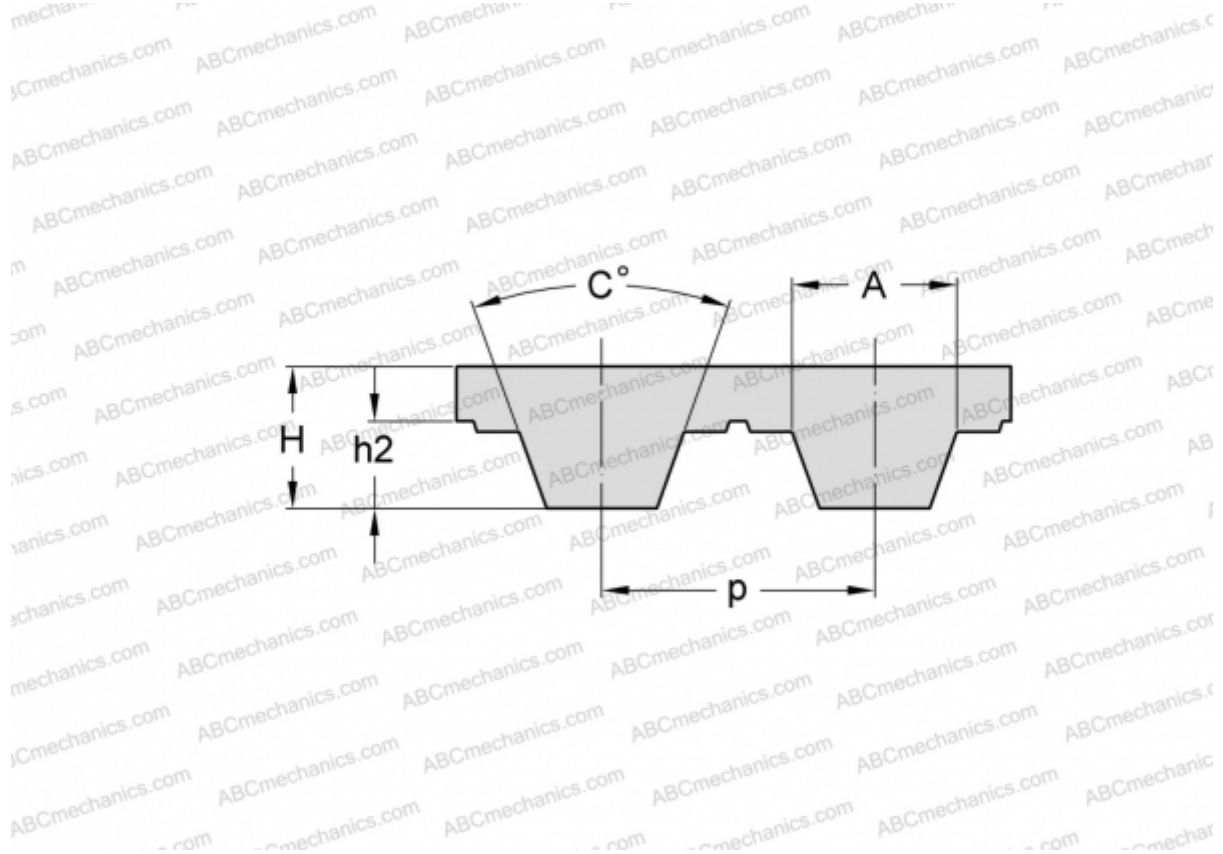

### Technical specification

#### DIMENSIONS, MM

Pitch teeth, p	5,000
Estimated length	800,000
Height, H	2,200
C	40,000
h2	1,200
A	2,650
Number of teeth	160

**MANUFACTURER** [SKF](#)