

PHG T5-1740-25 SKF

Metric timing belt, T section

TYPE: Classical timing belts, Oneway, Metric, Section T5 (SKF)

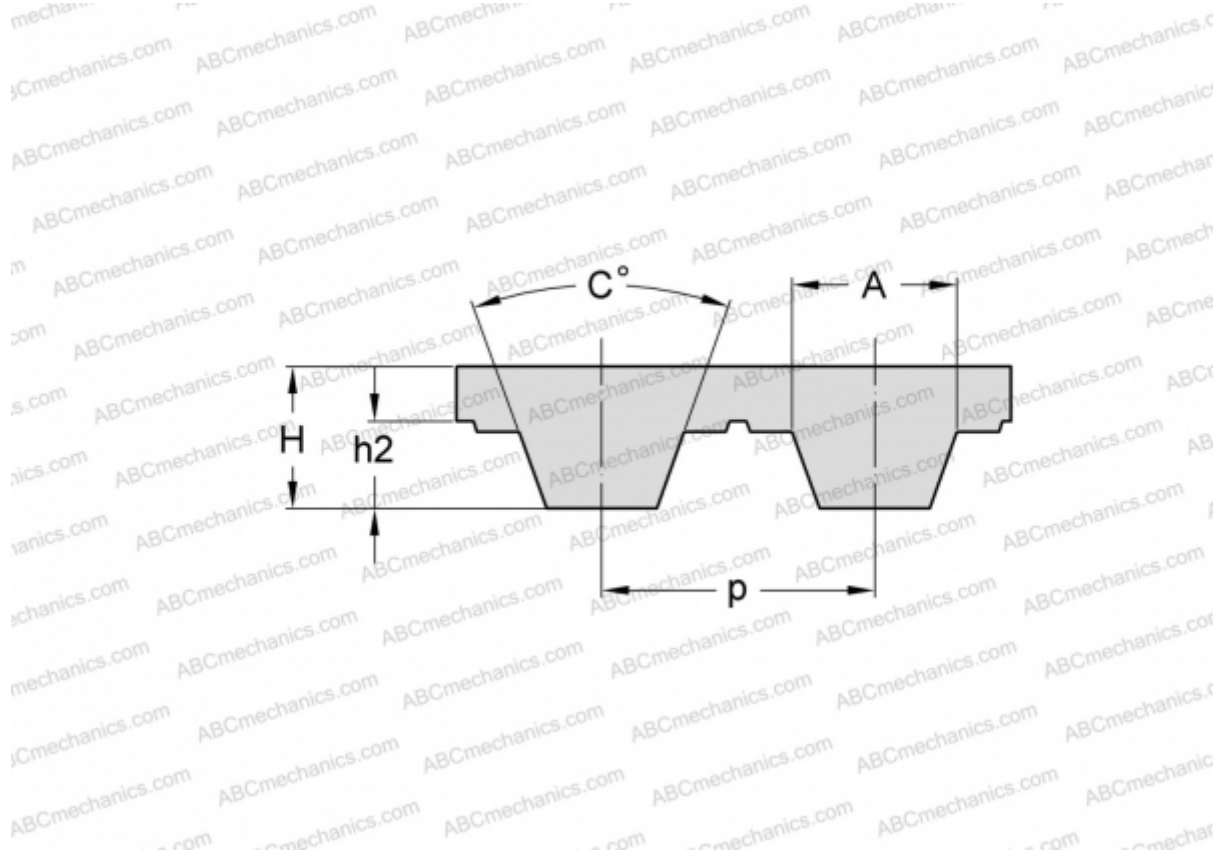

Technical specification

DIMENSIONS, MM

Pitch teeth, p	5,000
Estimated length	1740,000
Height, H	2,200
C	40,000
h_2	1,200
A	2,650
Number of teeth	348

MANUFACTURER [SKF](#)