

PHG T5-1900-25 SKF

Metric timing belt, T section

TYPE: Classical timing belts, Oneway, Metric, Section T5 (SKF)

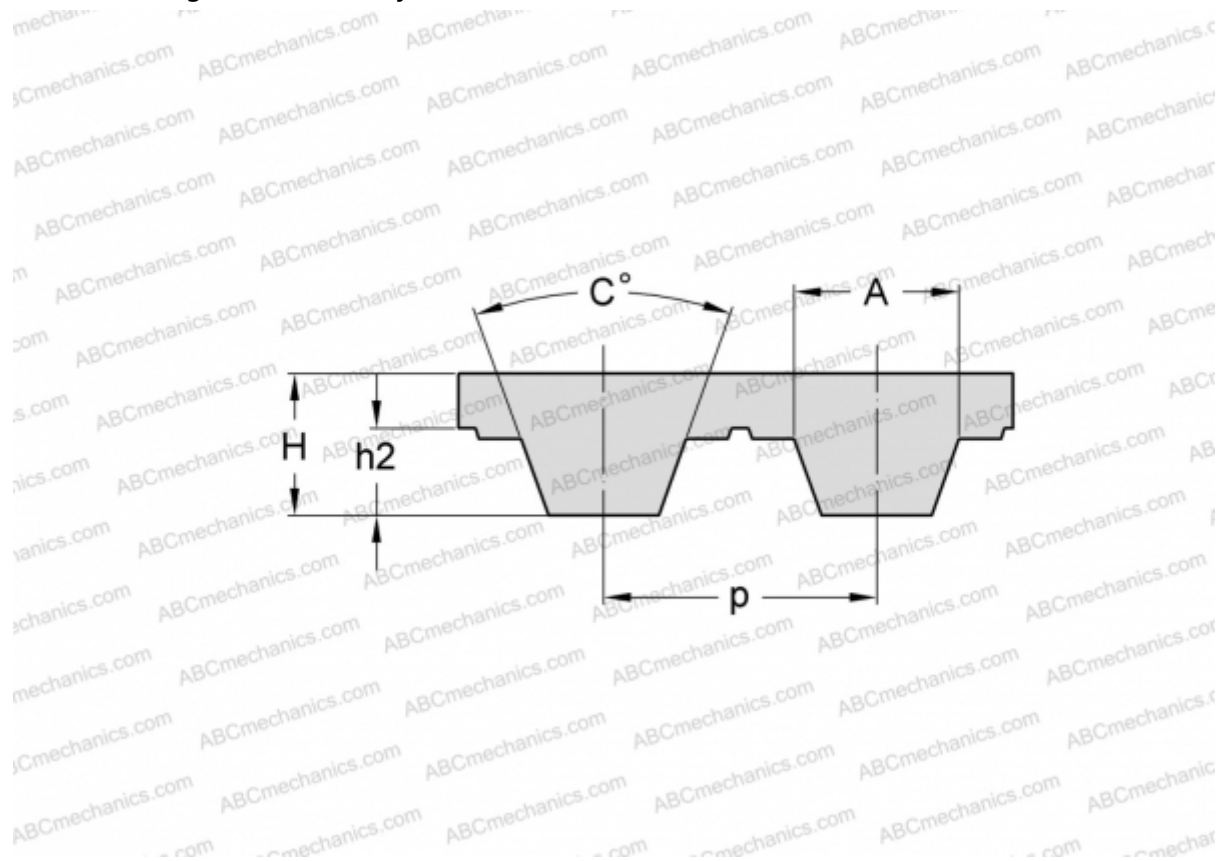

Technical specification

DIMENSIONS, MM

| | |
|------------------|----------|
| Pitch teeth, p | 5,000 |
| Estimated length | 1900,000 |
| Height, H | 2,200 |
| C | 40,000 |
| h2 | 1,200 |
| A | 2,650 |
| Number of teeth | 380 |

MANUFACTURER [SKF](#)